

VIII. *An Inquiry into the Variations of the Human Skull, particularly in the Antero-posterior Direction.* By JOHN CLELAND, M.D., Professor of Anatomy and Physiology, Queen's College, Galway. Communicated by Dr. ALLEN THOMSON, F.R.S.

Received June 15,—Read June 17, 1869.

CONTENTS.

	Page		Page
Introductory . . . . .	17	Height . . . . .	142
I. Cranium proper . . . . .	122	Proportion of height to frontal depth . . . . .	143
Extent of arch and base-line . . . . .	122	Length . . . . .	144
Regions of the base . . . . .	125	Proportions of height and breadth to length . . . . .	144
Foramen magnum . . . . .	125	Position of greatest breadth . . . . .	148
Orbital length . . . . .	125	Radial measurements and position of the ear . . . . .	149
Foramino-optic line . . . . .	126	II. The face . . . . .	152
Angles at which the three divisions of the base lie one to another . . . . .	127	The orbito-nasal angle . . . . .	154
Length of arc of different portions of the arch . . . . .	131	Length of face from fronto-nasal suture to nasal spine . . . . .	156
Length of chord of different portions of the arch . . . . .	132	Naso-basilar angle and naso-basilar line . . . . .	156
Angles expressive of the form of different parts of the arch . . . . .	134	Causes of prognathism . . . . .	157
Young skulls . . . . .	134	Relations of the upper jaw to the ear . . . . .	159
Gravitation changes . . . . .	136	III. Position of the skull on the vertebral column . . . . .	160
National differences . . . . .	137	Applications to artistic anatomy . . . . .	162
Deep frontal angle . . . . .	139	IV. Anomalous forms of skull . . . . .	164
Area of the frontal, parietal, and occipital parts of the diagrammatized profile . . . . .	140	Unusual magnitude . . . . .	164
Distance of the arch at various points from the base . . . . .	141	Hunchback . . . . .	165
		Cretins and idiots . . . . .	166
		Artificial deformities . . . . .	167
		V. Comparison of the human skull with the skulls of various animals . . . . .	168

THE following investigations were commenced about nine years ago, and some of the results were laid before the Physiological Subsection of the British Association Meeting at Manchester in 1861. Circumstances, during a series of years, prevented the writer from elaborating so fully as he desired the results of the measurements which he had already made; but this is the less to be regretted, as in the meantime he has had opportunity of making additional measurements, and the writings of others which have from time to time appeared have given him additional information without interfering with the line of inquiry which he proposed to himself to pursue. That inquiry was commenced in the belief that descriptions of crania expressing, however precisely, the

MDCCLXX.

R

surface-peculiarities which meet the eye, were not sufficient to determine the real nature of the differences existing between the crania of different nations or individuals; that it was necessary to consider the arch and the base of the skull in their connexion one with the other, and to measure the relations of parts by means of distances and angles more systematically than had been done; and that if this were done it would appear that there were far more important variations in the antero-posterior direction in skulls than were suspected, or than existed in their breadth. The various forms of forehead, vertex, and occiput are noted by anatomists without sufficient knowledge how these local appearances are related to the structure of the cranium as a whole. Even such generally used words as dolichocephalous, brachycephalous, orthognathous, and prognathous, though efforts have been made to render them perfectly explicit, refer to varieties of form which have not been properly understood.

*Mode of measurement.*—It may be frankly admitted that probably the system of “geometrical drawing” recommended and described by LUCAE\* would have been preferable in some respects to the mode of craniometry employed by the writer, but most of the measurements were made before LUCAE’S method was published. Also it may be admitted that vertical sections, which afford the most accurate of all bases for profile views, might have been used to a greater extent than they were; but there was a difficulty in asking that a number of skulls in Museums should be bisected for examination by a private individual. Still some bisections have been obtained, sufficient to illustrate the substantial accuracy of the system in most instances followed; and while mentioning this, it is right to say how much indebted the writer has been to the late Professor GOODSIR and Professor ALLMAN of Edinburgh, and to Professor ALLEN THOMSON, for their kindness in placing specimens at his disposal. The craniometer which the writer has employed is not without its advantages, being an instrument fitted to determine the exact relation of any point in space to a given starting-point. The skull is suspended in a horizontal frame by means of two pointed screws, one on each side, which work in fixed supports; and by other screws moving on slides it may be set with any two points on a level. A vertical bar, which can be slipped up and down, slides along the side of the frame, and bears a sliding horizontal bar directed inwards, to which a needle may be attached at right angles if necessary, in either a vertical or longitudinal direction. The frame, the bars, and the needle are all marked off in inches and tenths, and by this means the vertical and horizontal distance of any point on the skull from the place of suspension is easily determined and marked on paper, so that by a series of such points a diagram may be constructed. With the assistance of a sheet of ruled paper such a diagram may be constructed in a few minutes from a series of figures not occupying more than a couple of lines. It is convenient to register the number indicating the vertical position of a point with that indicating the horizontal position placed immediately below it, like the denominator of a vulgar fraction; while backward and downward directions may be respectively distinguished from forward and upward directions

\* Zur Morphologie der Rassenschädel, 1861, p. 16.

by placing — before the figure. Thus the following formula is sufficient for the construction of a diagram of the Irish skull 54:—

$$\frac{-4}{.05} \quad \frac{-7}{-1.35} \quad \frac{.1}{1.05} \quad \frac{-.65}{1.9} \quad \frac{-1.2}{3.5} \quad \frac{-.6}{3.65} \quad \frac{-.3}{-3} \quad \frac{.75}{-3.65} \quad \frac{1.9}{-3.65} \quad \frac{4.4}{-2.3} \quad \frac{.5}{.55} \quad \frac{3.85}{3.05} \quad \frac{1.8}{3.65} \quad \frac{1.3}{3.55} \quad \frac{1.1}{1.5}$$

If to this formula there be added the breadth at as many points as may be desired, and the positions of those points, the utmost completeness may be given to it. By this system of notation the outline of the profile of every skull in every Museum might be recorded with the greatest accuracy, either from measurements taken with the craniometer described, or from geometrical drawings, or tracings of vertical sections.

Close to the upper and posterior margin of the external auditory meatus there is in almost every skull a slight pit, which may be termed the postauricular depression, left between the margin of the meatus and the main part of the pars squamosa. This pit, from its minute size and its central and constant position, is well fitted for receiving the points of the screws by which the skull is kept in the craniometer, and for being the starting-point from which the horizontal and vertical distance of other parts may be computed; and even when the screws have to be fixed to some other part, as happens occasionally when the pits are ill marked, it is easy to correct the record of measurements so as to calculate the distances from the usual place. In making the craniometric measurements on which this communication is founded, the skull in each instance was first placed in the frame with the base upwards, and, while so fixed, the position was taken of the fore and hinder limit of the foramen magnum, the occipital tuberosity and the point midway between the tuberosity and upper angle of the occipital bone which is distinguished as the midoccipital point, also the spheno-occipital suture, the posterior limit of the hard palate in the middle line, the lowest point of the alveolar process between the middle incisors and the tip of the nasal spine. The skull was then turned round and fixed with the arch upwards, the sliding screws being replaced to support it at exactly the same level as when it was reversed. The positions of the midoccipital point and nasal spine were again taken, to secure against error from strain, and the accurate adjustment of the skull having been thus tested, one could proceed to take the position of the upper angle of the occipital bone, the middle point of the sagittal suture, its anterior extremity, the fronto-nasal suture, the point on the frontal bone midway between these two last points, and also the most prominent point of the glabella.

Sometimes the exact point which was to be considered as the one wanted for measurement had to be determined a little arbitrarily, but this did not occur to any great extent. Thus a difficulty of more than a line would often occur as to the exact point to be marked as occipital tuberosity; in infants a point in the anterior fontanelle had to be chosen as representing the junction of the frontal and parietal bones in the middle line; and often a difficulty would occur at the upper angle of the occipital bone from the presence of an os triquetrum; but this was usually solved by taking the point at which the limbs of the lambdoidal suture would have met had they passed up uninterruptedly. With regard to the spheno-occipital suture, while in young subjects the anterior margin of the

somewhat open suture was the point taken for measurement, in adult skulls the rough line was chosen which seems to form the limit between the two bones. In fact the writer supposed, in common with anatomists generally, that this line was the mark of the obliterated suture, but afterwards, suspecting the accuracy of this view, made a special examination and found that it was really the mark of attachment of the pharynx to the sphenoid bone, and that the position of the sphenoid-occipital suture was slightly further back, and disappeared without leaving any trace.

Besides the positions of the points on the skull already mentioned, it was necessary that another should be registered to indicate the extent of the anterior cranial fossa. For this purpose the outer edge of the foramen opticum was chosen, the needle being rested on it as far up as possible. It is quite true that a point in the mesial section would have been somewhat preferable to this, especially as the position of the foramen opticum varies a little in height in its relation to the floor of the anterior cranial fossa, but the point chosen has suited sufficiently well, and was the best which could be got in the circumstances.

The various points now indicated being marked on ruled paper and joined by means of straight lines, a diagram is produced on which it is easy to measure a great variety of lines and angles. The measurements on which the present communication is founded have been made from such diagrams, and the lines and angles measured are indicated by descriptive names.

In making any series of craniographic observations, it is desirable not merely to select carefully the measurements to be registered, but to determine in what position the skulls shall be placed for the sake of comparing their outlines; and in the present instance, as it was proposed to measure by vertical and horizontal distances, it was natural to attempt establishing a criterion by which a skull might be placed precisely as it had been during life when the person stood in the erect posture. On looking, however, at the numerous methods of placing the skull adopted by different observers, it is impossible not to see that we now touch on a most unsatisfactory part of the subject, and a fruitful source of error. This will appear more evidently in the sequel; meanwhile it is sufficient to state that all the plans proposed are arbitrary, and if any one of them be true, it has at least not been proved to be so. In the Anatomical Museum of the Queen's College, Galway, are placed the skulls of two criminals (skulls 49 and 50) with casts of the features taken immediately after death by Dr. CROKER KING, at that time the Professor of Anatomy and Physiology; and on comparing the skulls with the casts, it is clearly noticeable that they are not placed in the position which they occupied in the erect posture, and when looking directly forwards during life, by following any of the plans which have been recommended, or by using the rule which has been adopted in the present inquiry. In all probability the skull does not possess any two points which in every instance lie in one vertical plane, or one in front of the other in a horizontal plane; and it is quite likely that it will always remain impossible to determine from the characters of a skull what was its precise position in the erect posture of the body. But



the only modes by which accurate information can be arrived at appear to be by extensive examination of the living subject, and by comparison of the skulls of the dead with carefully taken casts of the features. Early in these inquiries it occurred to the writer that doubtless the same principle of balance came into play in the support of the head as in the rest of the body, but that as the proportions of the head are very different at different ages, the position of balance on the vertebral column must be different at different periods of life. Proof will be adduced in support of this proposition further on; but it is necessary now to mention that it was with the view of collecting evidence on this point that the arbitrary horizontal line was chosen which has been used throughout the present investigations, and which was obtained as follows. The skull to be examined having been placed in the frame with the base upwards, a flat slip of wood was rested on the condyles and posterior boundaries of the foramen magnum, and allowed to project backwards; the skull was then rotated till the wooden slip was in the horizontal position. Now, probably in most cases the posterior limit of the foramen magnum is close to or rests on the arch of the atlas, and in elderly subjects it is not uncommon to find a flat facet at the back of the foramen magnum indicating this contact. If, therefore, the deepest parts of the upper articular surfaces of the atlas and the posterior arch of that bone lay in a horizontal plane, the skull would be correctly placed by the means now described. Unfortunately, however, this is not always the case; and all that can be maintained is that some approximation to accuracy is thus reached, which will probably be admitted on examination of the majority of the accompanying diagrams. To eliminate, therefore, as much as possible an element in which uncertainty is inherent, the measurements in the present inquiry have been all made so as to be independent of the position of the skull, except in the section in which the question of position is itself considered.

To prevent the possibility of any mistake, it may be proper to explain at the outset that all statements which will be made with regard to national forms of crania are to be understood as referring simply to the results of the measurements of the skulls enumerated in the General Table; and as it will be observed that in the case of some nationalities the specimens are too few in number, and in many instances the history is less complete than would be desirable, the statements founded on those specimens are not put forward dogmatically as of general application, but rather as suggesting probable laws which must be left for other observers to investigate. When the form of the Greek skull is spoken of, it is of course only the Modern Greek which is alluded to; and the peculiarities exhibited by each of the five Greek skulls examined makes the writer particularly regret in this instance the paucity of specimens and the incompleteness of their histories. So also it is much to be regretted that there is no record of the particular part of Germany from which any of the eight German skulls examined have been obtained, and that therefore it has been impossible to distinguish between North and South German.

## I. CRANIUM PROPER.

*Extent of arch and base-line* (General Table, columns 6, 7, 8).—When it is considered that one of the most marked peculiarities of the human skull is the great elongation of the arch and shortening of the base, it becomes interesting to know what relation the length of arch has to the length of base at different ages and in different nations. The length of arch has been measured along the middle line of the roof, from the fronto-nasal suture to the back of the foramen magnum, while the direct distance between the same points has been taken as base-line. The distance from the occipital tuberosity to the foramen magnum is best included along with the arch, because, whether its variations or its morphological constitution are regarded, it appears to be closely associated with the arch, and because it has been found in making the measurements that the tuberosity is not a good land-mark, but varies in position according to its prominence. The foramen magnum is best considered as part of the base; for although, when we take into account the development of the medullary canal, and the appearance of parts in the lower animals, the strict base of the skull must be looked on as commencing at the front of the foramen magnum, or opposite the condyloid margins of the basilar ossification of the occipital bone, still we shall find that such a close connexion exists between the angles at which the foramen magnum and the floor of the anterior cranial fossa respectively lie to the intermediate portion of the cranium, that it is convenient to consider all three as belonging to the base.

The general average proportion which the length of the arch bears to the base-line in the adult may probably be estimated at about 2·70 : 1; but it varies considerably both in individuals and nations.

So far as one may judge from the foetal skull examined, it would appear that before the middle period of foetal life the arch is considerably less developed in proportion to the base than it is in the adult, but that afterwards the proportion is altered by the great growth of the arch, so that in the later months it is about three to one. In new-born infants and in children it more frequently exceeds than falls short of this proportion; the average found in five skulls of new-born infants being 3·06 : 1, and the average in seven children of ages varying from one to ten years being 3·07 : 1. The ten-years-old skull is the only one of these seven in which the base-line has acquired a length which might be permanent, while in four of them the arch is such as might be found in the adult. We may judge therefore that the base-line continues to elongate after the arch has acquired its permanent dimensions.

On examining the proportion of arch to base-line in adults we find, as we shall also find in all other measurements, that the variations in individuals of one nation are so great that the minimum figure in a nation in which the proportion is high is always within the limits of variation found in nations in which it is low; and that therefore it is very necessary to compare different specimens of one nation together. Much the smallest proportion of arch to base in the series of skulls examined is in the Esquimaux skull 77, in which it is 2·28 : 1; but in the other Esquimaux it is 2·67, as high as the

average of the French skull. The Kafir, the Negro, the Australian\*, the Greek, and the French skulls show little difference in this proportion, their averages varying from 2.61:1 in the first to 2.67 in the last. The Irish have the proportion highest, 2.89:1; and next them come the Chinese\*, closely followed by the German, 2.80, and these by the Hindoo, 2.78. The highest proportion found among the Irish skulls, it will be observed, exceeds the average proportion in infants.

Proceeding to analyze the effect of sex on the proportion of the arch to the base, it appears that in five out of seven nationalities, in which several skulls have been examined, one or more of which have been females, either the highest or lowest extreme of proportion is in a female; and the cause of this is that in the female the base-line is almost always short, while the extent of the arch is in some instances as great as in the male, and in others diminished to a greater proportional extent than is the base. To clear the averages from the disturbing effects of the introduction of a varying number of female skulls in different nationalities, and to exhibit the peculiarities of sex now stated, a Table has been made exhibiting the average proportion of arch to base-line in males and females separately.

\* In order to obtain a sufficient number of measurements by which to judge of the proportions of arch to base, and of the parts of the arch, in Chinese and Australian skulls, the writer has availed himself of the "geometrically drawn" figures given by LUCÆ in his work 'Zur Morphologie der Rassenschädel,' and made on them measurements the results of which have been combined with the measurements given in the General Table, in estimating averages, and are therefore here given. The columns are numbered the same as the corresponding columns in the General Table.

	3.	4.	5.	6.	7.	8.	9.	10.	11.	12.	13.	14.	15.
LUCÆ, XXI. 7, Chinese from Java, with Javan blood .....	4.4	5.5	5.	14.9	5.7	2.61	80	90	3.9	5.	4.4	78	88
" XXI. 5, " " " " .....	4.3	5.9	5.	15.2	5.4	2.81	72	84	3.7	5.1	4.4	72	86
" XXI. 3, " " " " .....	4.1	5.6	4.9	14.6	5.1	2.86	73	87	3.7	4.8	4.4	77	91
" XXI. 6, " " with Javan mother .....	4.	5.4	5.2	14.6	5.2	2.80	74	96	3.5	4.7	4.5	74	95
" XXI. 8, Pure Chinese.....	4.3	5.3	5.3	14.9	5.2	2.86	81	100	3.8	4.7	4.7	80	100
Chinese, 85 of the General Table .....	4.8	4.8	4.8	14.4	4.8	3.00	100	100	3.95	4.3	4.2	91	97
Average .....	4.31	5.41	5.03	14.76	5.23	2.82	80	92	3.75	4.76	4.43	78	92
LUCÆ, XXII. 10, Australian male .....	4.3	5.1	5.2	14.6	5.4	2.70	84	101	3.5	4.6	4.5	76	97
" XXII. 11, " " .....	4.6	5.	5.5	15.1	5.5	2.74	92	110	3.8	4.6	4.7	82	102
" XXII. 12, " " .....	4.	5.3	4.3	13.6	5.4	2.51	75	81	3.5	4.6	3.9	76	84
" XXII. 9, " " .....	4.6	5.2	4.7	14.5	5.5	2.63	88	90	3.6	4.6	4.2	78	91
" I. a 322, " female.....	3.8	5.3	4.3	13.4	4.9	2.73	71	81	3.4	4.7	3.8	72	80
Australian, 72 of the General Table .....	4.4	5.2	4.9	14.5	5.5	2.63	84	94	3.7	5.	4.3	74	86
" 73 " " .....	4.25	5.1	4.9	14.25	5.4	2.63	83	98	3.5	4.7	4.5	74	95
Average .....	4.27	5.17	4.82	14.27	5.37	2.65	82	93	3.57	4.68	4.27	76	90

It must not be forgotten that four of LUCÆ's Chinese skulls are from persons with Javan blood by the mother's side.

	Numbers measured.	Males.			Numbers measured.	Females.		
		Arch.	Base.	Pro-portion.		Arch.	Base.	Pro-portion.
Esquimaux .....	2	13·85	5·6	2·47	3	13·96	5·	2·79
French .....	6	14·	5·36	2·61				
Hindoo .....	3	14·2	5·1	2·78				
Greek .....	5	14·2	5·3	2·69	2	14·3	5·15	2·77
Negro .....	5	14·3	5·52	2·58				
Scotch .....	4	14·36	5·3	2·70	2	14·85	5·3	2·78
Australian .....	6	14·42	5·45	2·64	1	13·4	4·9	2·73
Kanaka .....	1	14·6	5·5	2·65	1	14·7	5·	2·94
Chinese .....	6	14·77	5·23	2·82	3	13·73	4·96	2·76
German .....	5	14·82	5·24	2·82				
Kafir .....	3	15·06	5·66	2·65				
Irish .....	6	15·23	5·23	2·91	3	14·56	5·1	2·85

This Table shows constant shortness of base-line in the female, while the arch is only sometimes shorter than in the male. The proportion of arch to base-line is usually larger in the female skulls examined than in the male, as is held to be the rule by WELCKER and ECKER; but in the German, Irish, and Kafir skulls, in which this is not the case, the reason is that though the base-line is shorter than in the male, the arch differs still more from the male arch.

The Table also brings out more distinctly than before the very large proportion of arch to base in the Irish, which will probably be found to be a marked and general national character. It further shows that the proportion of arch to base in a nation may vary from either arch or base-line deviating from the average, or from deviation of both; and therefore probably the actual length of these measurements is of more value than the proportion of one to the other. The most striking and altogether remarkable fact is that in uncivilized nations, while the length of the arch is very variable, the length of the base-line is always great. Thus in length of arch the three Kafir skulls exceed all other skulls in the foregoing Table, with the exception of the Irish, but the Kafir base-line exceeds the Irish by not much less than half an inch. In the Esquimaux skull 77, and the Carib skull 88, both of them skulls of most savage type, the base-line reaches the extraordinary length of 5·9. In only one European skull, the French 24, has a base-line of 5·7 occurred, while in only two others, the French skull 22, and the Scotch skull 38, it has amounted to 5·6. The low proportion of arch to base in the French skulls depends on a concurrence of a long base-line with a short arch, three out of the six males having the base-line 5·5 or more, and four of them having the arch 13·8 or less. The Irish, German, and Chinese skulls very closely agree in average length of base-line; but the Irish have greater proportionate extent of arch, because in them the arch is absolutely greater, reaching as it does to a greater length than has been obtained in any other skulls in the series. The shortest arch and shortest base are found united in the Peruvian skull 78; the Scotch skull 37 has as short an arch, but its base-line is longer.

In only one out of the fifteen female skulls examined does the base-line reach to 5·4,

and in two to 5·3; in the remainder it varies from 4·9 to 5·2, while we have already seen that in the child ten years old it reaches 5·1. It appears from this that the additional growth by which the base-line in the male comes to exceed that found in the female takes place after the age mentioned. It might therefore be naturally supposed, as occurred to the writer, that the facts which have now been detailed are mere results of greater development of the frontal sinus in the adult male than in the female and child, and in the savage than in civilized races; but this is not the case; for we shall find that though development of the frontal sinus does add to the base-line, growth of the base of the skull from the front of the foramen magnum forwards to the level of the foramina optica plays a much greater part in the addition which takes place.

*Regions of the base.*—According to the system of measurement pursued in the present inquiry, the base of the skull is represented by three lines, the middle one of which, the foramino-optic line, corresponds pretty nearly with the ‘basicranial axis’ of HUXLEY; while the hindmost displays the length of the foramen magnum, and the foremost the length of the orbit; the length of the base-line varying according to the length of these distances, and the angles at which they are placed one to another.

*Foramen magnum* (General Table, column 25).—This is the region of the base which presents least characteristic variation in length. It usually measures from 1·4 to 1·5. The extremes met with are 1·25 and 1·70. Little or no distinction of a national character is discoverable in its variations; and although skulls which have a markedly long base-line sometimes owe the peculiarity in a small degree to the length of this foramen, as Esquimaux 77 and Kafir 69, there are other skulls, such as 23 and 56, and the infant skull 11, which combine a long foramen magnum with a short base-line. The proportion borne by the foramen magnum to the base-line does not appear to undergo any constant alteration in the passage from infancy to adult age.

*Orbital length* (General Table, column 27).—This measurement likewise has the same proportion to the base-line at birth as in the adult. In the six-years-old as well as in the twelve-years-old child it is of a length which might be permanent; in the adult male it is slightly but distinctly greater than in the female. The national variations are well worthy of remark. If influenced by the belief that large development of the frontal part of the skull accompanies intellectual capacity, we might expect to find a greater orbital length in civilized than in savage nations. But this is not the case. LUCÆ, in his comparison of European and Australian skulls, pointed out that the floor of the anterior fossa of the skull was quite as well developed in the latter as in the former\*; and this observation is quite in harmony with the present measurements, although unfortunately he has accompanied it with the hasty remark, not borne out by his drawings, that the Australian development is defective in the upper part of the frontal region.

In the meantime, however, let us consider simply the orbital length. The range of its variation in the great majority of skulls is from 1·8 to 2·1. In the Australian, Negro, and Kafir the average is high, while in the French and German it is shorter than in any

\* LUCÆ, *op. cit.* p. 40.

but the brachycephalous Americans. But the amount of orbital length in the Australian, Negro, and Kafir is not sufficient to account for the great length of base-line of these skulls; the Greek, the Hindoo, and the Irish skulls agree with them in the average orbital length, while in these, especially in the Hindoo and Irish, the base-line is much shorter. At the same time the orbital length is to be recognized as one element on which length of base-line depends; and examination of the different skulls of each nation shows that the extent of the orbital length usually varies in harmony with that of the base-line.

The adult skulls in which the orbital length is less than 1·8 are the male and female French skulls 23 and 26, the female German 34, and the Chinese 85, all of them well-proportioned skulls. The anomalous male French skull 89 cannot be taken into account, since in it the shortness of the orbit (1·6) is obviously the direct result of early synostosis of the lower part of the coronal suture on each side, and has been compensated for by undue height of the cranial arch, the result being a very peculiar deformity.

In the following skulls the orbital length is above 2·1, viz. :—in BURKE, in the Greek 48, in the male Kanaka, in the Australian 73, and the Negro 62 it measures 2·15; in Hindoo 60 and in the Hottentot Chief and the Idiot it measures 2·2; and in the Carib 88 it reaches the extraordinary depth of 2·4. The list thus contains some of the very ugliest skulls examined; and of the nine only three, namely, the Greek, the Hindoo, and the aberrant skull of BURKE, belong to civilized nations.

So far, then, as these observations extend, it would appear that shortening of the orbital length never occurs as a feature of degraded national type, but that elongated orbital length does so occur. Where it does so, the probability is that the elongation is in connexion rather with development of the frontal sinus or diploë than of the cranial cavity. It produces antero-posterior elongation of the nasal fossæ in their upper part, which may perhaps be favourable for the expansion of the olfactory nerve and production of a keen sense of smell.

*Foramino-optic line* (General Table, column 26).—This line, extending from the front of the foramen magnum to the point midway between the foramina optica, and thus indicating the middle portion of the base, corresponds, as has been said, pretty closely with Mr. HUXLEY'S "basicranial axis"\*, which, starting from the same point, passes to the junction of the sphenoid and ethmoid bones in the anterior cranial fossa. Probably the one line is as well chosen as the other; and it may be frankly admitted that a line drawn to the angle of separation of the middle and anterior cranial fossæ in front of the optic commissure might be preferable to either.

In new-born infants and in children the foramino-optic line is about equal in extent to the orbital length, whereas in the adult it usually exceeds it. In the ten-years-old skull it is of such length as might possibly be permanent, being of a length not uncommon in the adult female. The extent of this line in the female is less than in the male, the difference between the sexes in this respect being still more distinct than in the ex-

\* Journal of Anatomy and Physiology, November 1866, p. 67.

tent of orbital length. The Table shows an apparent exception to this statement in the

	Males.			Females.		
	Number measured.	Orbital length.	Foramino-optic line.	Number measured.	Orbital length.	Foramino-optic line.
German .....	5	1·93	2·13	3	1·8	2·03
French .....	6	1·95	2·24	3	1·83	2·03
Scotch .....	5	2·	2·22	2	1·95	2·3
Irish .....	6	2·05	2·09	3	1·91	1·93
Greek .....	5	2·05	2·18			
Kafir .....	3	2·05	2·36	1	2·	1·95
Hindoo .....	3	2·05	2·1			
Negro .....	5	2·07	2·32	2	1·92	2·12
Australian ...	2	2·1	2·2			
Kanaka .....	1	2·15	2·3	1	2·05	2·1

case of the Scotch skulls; which arises from one of the two female skulls having the exceptionally long foramino-optic line of 2·4, a mere individual aberrancy. Occurring, however, in a skull known beyond all possibility of question to be female, and in other respects having female characteristics, it affords a good illustration that the characters of sex, although more constant than those of nationality (HUSCHKE\*), are, like them, not all present in every instance. Examining the length of the foramino-optic line in different nations, it is found to be shortest in the Irish, Peruvian, and Hindoo, partly accounting for the shortness of base-line in those skulls, and to be longest in the Kafir and Negro skulls, which have the base-line long. Also, an inspection of those skulls in which the foramino-optic line amounts to or exceeds 2·4 shows that length of this line, like great orbital length, is a character liable to be found in skulls of low type. But it is likewise long in others which cannot be so classed. Thus the female Scotch skull 43, already alluded to, and the French skull 24, in both which the foramino-optic line measures 2·4, and the Kafir skull 45, in which it is 2·45, are not skulls of a low type; but the French skull 20, in which this line measures 2·45, is the worst proportioned of the six French males, and has a depression at the top of the coronal suture which has probably been the direct result of spheno-parietal synostosis. In the Negro 61 and the Carib 88, the foramino-optic line measures 2·4; in Esquimaux 77 and Kafir 68, it measures 2·5; in the Maori 2·55; while it reaches the unwonted length of 2·6 in the Spanish pirate, a skull which in various respects may be described as being as peculiar in character as the man to whom it belonged is said to have been savage.

*Angles at which the three divisions of the base lie one to another* (General Table, columns 28, 29, 30).—The angles which the foramen magnum and the orbital length respectively form with the foramino-optic line may be termed the *foramino-basilar* and *orbito-basilar angles*. The number of degrees between the line of the foramen magnum and the line of orbital length on the upper side may be termed the *cranial curve*; for if we look on the cranial cavity as the continuation of the cylinder of the spinal canal

\* Schädel, Hirn, und Seele, p. 2.

curving rapidly forwards, and consider the incisura of the frontal bone as being morphologically its distal extremity, then the angle mentioned indicates approximately the amount of curve which exists. When the foramino-basilar and orbito-basilar angles are equal, the foramen magnum and the orbital length lie at an angle of  $180^\circ$ , or, in other words, are parallel. According as the orbito-basilar angle is greater or less than the foramino-basilar, the cranial curve is less or greater than  $180^\circ$ .

The foramino-basilar and orbito-basilar angle and the cranial curve require to be all considered together; and this is more particularly the case, since it is a remarkable fact that, while the foramino-basilar and orbito-basilar angles have a wide range of variation, the adult cranial curve varies within much more restricted limits; or in other words, the difference between the foramino-basilar and orbito-basilar angles in any skull being limited, these angles are to a considerable extent interdependent. Thus in the Kafir skull 68, the foramino-basilar angle measures  $128^\circ$ , and in the female Kafir it is  $150^\circ$ ; the orbito-basilar angle of the skull of the Hottentot measures  $129^\circ$ , and that of the Greek skull 46 measures  $150^\circ$ ; but a cranial curve  $21^\circ$  more or less than  $180^\circ$  is probably never to be met with in any undeformed skull. One female French skull, 25, has a foramino-basilar angle of  $162^\circ$ , while another, 26, has an orbito-basilar angle of  $128^\circ$ ; but these two angles could not coexist in any skull except with very great deformity; were they to do so they would give a cranial curve of  $214^\circ$ ; and the only skull in which so great a curve is approached is 91, the skull with the base driven in, in which the curve is  $212^\circ$ .

While in adult European skulls the cranial curve seldom falls short of  $180^\circ$  by more than three or four degrees, and more frequently exceeds that amount, in the six foetal skulls examined it varies from  $150^\circ$  to  $176^\circ$ . As, however, those in which the amount of curve is lowest are skulls of fetuses of the 4th, 7th, and 8th month, while the highest amounts occur in a fetus of the 5th and another of the 8th month, it would appear that the increase of curve proceeds more rapidly in one skull than in another. A smaller degree of the same irregularity is seen on comparing the five skulls of new-born infants; these seem, however, clearly to show that the cranial curve is not quite completed at birth, while an examination of the skulls of older children shows that at least in some instances it is completed before the third year.

	Males.				Females.			
	Number measured.	Foramino-basilar angle.	Orbito-basilar angle.	Cranial curve.	Number measured.	Foramino-basilar angle.	Orbito-basilar angle.	Cranial curve.
Kafir .....	3	$133\frac{2}{3}$	$144^\circ$	$169\frac{2}{3}$	1	$150^\circ$	$144^\circ$	$186^\circ$
Esquimaux...	2	$132\frac{1}{2}$	$141\frac{1}{2}$	171				
Negro .....	5	136	139	177	2	137	138	179
Kanaka .....	1	129	132	177	1	138	129	189
Greek .....	5	138	$140\frac{3}{4}$	$177\frac{1}{4}$				
Hindoo .....	3	128	$127\frac{1}{3}$	180				
Australian ...	2	$139\frac{1}{2}$	$138\frac{1}{2}$	181				
French .....	6	$141\frac{2}{3}$	$139\frac{3}{4}$	$181\frac{5}{8}$	3	$145\frac{2}{3}$	138	$187\frac{2}{3}$
Scotch .....	5	$135\frac{3}{5}$	$133\frac{2}{5}$	$182\frac{1}{5}$	2	$139\frac{1}{2}$	$136\frac{1}{2}$	183
Irish .....	6	$143\frac{2}{3}$	139	$184\frac{2}{3}$	3	$147\frac{1}{3}$	140	$187\frac{1}{3}$
German .....	5	$146\frac{2}{5}$	$139\frac{1}{5}$	$187\frac{1}{5}$	3	146	$141\frac{1}{3}$	$184\frac{2}{3}$



A perceptible difference exists in respect of cranial curve between the skulls of different nations, and this difference displays a distinct relation between the amount of curve and the length of base-line. Taking males only into account, the greatest cranial curve is found in the German skulls, in which the average amounts to  $187^{\circ}$ , and next to them come the Irish; while in the Kafirs the average is lowest, amounting to  $169^{\circ}$ ; and next them come the Esquimaux and Negro. Thus the German and Irish skulls, which have the base-line short, are highly curved, while the Kafir and Negro skulls, which have the base-line long, are less curved. So also, excepting in the case of the Germans, the average curve of the female skulls is greater than the curve of the males of the nation to which they belong. These differences recall to mind VIRCHOW'S theory of kyphosis in the skulls of Cretins, according to which, in cases of premature synostosis of the base, increased curvature supplies a means of enlargement of the cranial cavity, which to some extent compensates for the arrested basal growth. Without venturing to agree with that theory in its details, as an explanation of the pathological form of the skull in Cretins, to which further reference will be made, it may be allowed to allude to it as the first recognition of the principle that increased curving of the base of the human skull is a means by which the cranial cavity may be enlarged\*. In the estimate, however, of the cranial curve now being made there is included an important element not taken into account in VIRCHOW'S *angula sellæ* (*sattelwinkel*) or any modification of it, viz. the foramino-basilar angle, which indicates the degree in which the commencement of the inferior wall of the cranial cylinder is bent forwards from the spinal inlet; and since, as has been seen, this angle compensates and to a great extent varies with the curve estimated in this paper by the orbito-basilar angle, and which VIRCHOW estimated by means of his *angula sellæ*, it is quite evident that the increase of cranial curve now spoken of as a means of expansion of the cranial cavity is entirely different in detail from VIRCHOW'S kyphosis. The size of the foramino-basilar and orbito-basilar angles individually varies according to a totally different law from that which regulates the cranial curve; and seeing that accordingly as the foramino-basilar angle is large or small, so also to a certain degree is the orbito-basilar, the base of a skull may be termed *level* when both angles are large, and *steep* when both are small.

The base of the skull at birth is more level than afterwards, and it is still more level before birth. In the fœtus of the fourth month, in consequence of the want of development of the arch as compared with the base, a remarkable steepness or want of opening of the foramino-basilar angle is combined, contrary to the rule in the adult, with a very large orbito-basilar angle. In all the other skulls of fœtuses and infants examined the orbito-basilar angle is above the adult average, and in most of them the foramino-basilar angle is likewise large, although in the eight months' fœtal skull 6 and the infant

\* It will appear in the sequel that diminished curving of the base may likewise become a means of enlarging the cranial cavity. Increased curving is only a means by which the base accommodates itself to the growth of the roof-bones when its own growth is limited; but if the arch and base be each of a given length the cranial capacity will be increased by diminishing the curve of the base.

skull 10 it is small, and makes the cranial curve likewise exceptionally small. Scarcely any national distinction can be determined from the present measurements in respect of levelness and steepness of base, both conditions being met with in most of the national lists; but it may be noted that all the three Hindoo skulls have marked steepness of base, and this is one of the elements which make those skulls shorter and higher than most of the others.

The averages of the basal angles in females show in the Table in each case a somewhat greater levelness of base than the males of the same nation. Some of the most level bases belong to females, and are accompanied with great cranial curve. As illustrations of this, the French and German female skulls 25 and 34 may be mentioned; and it may be remarked that in this, as in many other matters, a specially feminine character may be seen to be given to a skull by the persistence of the form of childhood.

The following list of skulls in which the cranial curve is  $174^{\circ}$ , or a smaller amount, will serve to show that very frequently a slight cranial curve is combined with more than average steepness of base. The most marked instances in which this is not the case can be somewhat explained away. Thus in the Greek skull 46 the slightness of the cranial curve, as well as the length of base, depends on a peculiar idiosyncrasy which will be made the subject of comment hereafter (p. 165); the compressed and flattened American skulls 95 and 96 owe their want of curvature, as will be subsequently shown (p. 167), to the mode in which they have been deformed; and in the synostotic skull 89 the same arrest of the forward growth of the cranium which has caused the brain to push the roof of the skull upwards, has caused it to push the base downwards in the region of the orbito-basilar angle.

Numbers in General Table.	Description.	Base-line.	Cranial curve.	Foramino-basilar angle.
46	Greek .....	5·6	$172^{\circ}$	$142^{\circ}$
63	Negro .....	5·7	170	139
64	Negro .....	5·4	174	138
68	Kafir .....	5·8	165	128
69	Kafir .....	5·7	168	137
77	Esquimaux .....	5·9	164	129
81	Spaniard .....	5·5	172	126
83	Turk .....	5·1	174	133
86	Maori .....	5·7	167	126
88	Carib .....	5·9	171	125
89	Synostotic French .....	5·	172	140
93	Hunchback .....	5·35	169	126
95	Compressed Chinook ...	5·3	173	141
96	Flattened American ...	4·95	166	144

This list also shows that slightness of cranial curve is usually an accompaniment of long base-line; the Turkish skull is, however, a good example of slightness of curve and short base-line going together; and it is fair to note that in the French skull 22 there is a marked instance of a long base-line and a more than average cranial curve going together.

*Length of arc of the different portions of the arch* (General Table, columns 3, 4, 5, 9, 10). *Young skulls*.—It is well known that in early life the frontal and occipital parts of the skull are smaller as compared with the parietal than in the adult\*; and in accordance with this an examination of the Table shows that in foetal life, infancy, and childhood, the length of the frontal and of the occipital portion of the arch both bear, as a general rule, a smaller proportion to the length of the parietal portion than they do in the adult. It is not, however, to be supposed that the parietal has a predominance over the frontal and occipital region from the first, and that these grow proportionally larger in an equable manner; for setting aside the consideration that in the young embryo the wall covering the posterior cerebral vesicle is much larger than what is afterwards to become the parietal and frontal part of the cranium, and confining attention to the measurements in the Table, it appears that from the fourth month of foetal life till birth, while the disparity between the parietal and occipital regions is diminishing, the disparity between the parietal and frontal is increasing. Five of the six foetal skulls examined have the occipital smaller in proportion to the parietal than it is in the skulls of the new-born infants, and four out of the five skulls of infants have the frontal smaller in proportion to the parietal than it is in the foetal skull. The conclusion from this is that the parietal has grown more than the frontal, and the occipital more than the parietal in the later months of foetal life. But after birth the frontal, which has been for a time the slowest growing region, begins to expand most rapidly of the three, while the occipital region still continues to expand more rapidly than the parietal. This is indicated in the General Table by the children's and adult skulls having the proportionate length of the frontal, as compared with the parietal region, much higher than the new-born infants, and likewise having the proportion of the occipital to the parietal region higher than the infant skulls, though not greatly so.

It further appears, on estimating the percentage of the whole arch formed by each region respectively, that already in the youngest foetus examined the frontal region forms as high a proportion of the whole arch as it does in the adult, but that at birth the proportion is temporarily diminished; while the percentage belonging to the parietal region goes on diminishing, and the percentage belonging to the occipital goes on slightly increasing, from the youngest foetus examined till the adult skulls are reached†. No doubt the result is obscured by the large amount of individual variation which exists in different skulls, and to arrive at a precise estimate of the average extent of each region at different periods of development would probably require the examination of a large number of skulls; but a careful review of the figures justifies the statement now made.

Taking a survey of the growth of the cranium from the earliest period, the following account is probably correct. At first, in the early embryo, the occipital region is much

\* HUSCHKE, 'Schädel, Hirn, und Seele,' p. 46.

† The percentage which each portion of the arch forms of the whole, though calculated, is omitted from the General Table, to prevent unnecessary multiplication of figures.

the longest; then, when the cerebral hemispheres begin to expand, growth passing forwards, the parietal grows so rapidly as to exceed its proportion in the adult, and the frontal so rapidly as to attain to the adult proportion: in the latter half of foetal life, when the hemispheres push backwards over the cerebellum, growth goes on again more rapidly in the back than in the fore parts of the cranium, so that while the parietal region maintains its proportional length to the whole arch, the proportion of the occipital region increases, and that of the frontal diminishes: lastly, after birth, the proportional length of the occipital region increases slightly, and that of the frontal region much more markedly till the adult proportions are attained, which appears to be at a variable period within a few years after birth.

*Adult skulls.*—In the adult skull the individual variation in the proportional length of the different regions of the arch is very considerable, and the national variation for the most part only slight, while no sexual variation can be safely deduced\*. Such national variation as exists, however, is of a definite kind. The proportional length of the frontal region as compared with the parietal varies pretty nearly *pari passu* with the proportional length of the occipital region, or, in other words, the variation in proportion arises almost entirely from lengthening and shortening of the parietal region. Thus the French and German skulls have both the largest proportion of frontal region and the largest proportion of occipital region to parietal; and more markedly the Chinese and Australian skulls have both the frontal and occipital region of considerably smaller length as compared with the parietal than is usual. This is the more remarkable in the case of the Chinese, since it has been already noted that they have the additional childlike peculiarity of shortness of the base as compared with the arch†.

*Length of chord of different portions of the arch*‡ (General Table, columns 11, 12, 13, 14, 15).—In estimating the length of the different regions of the arch, it seemed advisable to measure not merely the arc of each portion, but likewise its direct length or chord; for it seemed possible that local bulgings and flattenings might produce variations

\* It may indeed be noted that the highest proportions of occipital to frontal are nowhere to be found in the list of female skulls measured; but the writer is inclined to impute this to the uniform absence of that degree of muscularity which leads to great prominence of the occipital tuberosity and consequent increase of the surface length of the occipital bone. It would not be surprising, however, if an examination of a large number of female skulls were to show on the average a diminished proportion of both occipital and frontal arc to the parietal when compared with male skulls; such a result would harmonize with HUSCHKE'S statement, that in the female the capacity of both the occipital and the frontal segment is smaller in proportion to the parietal than in the male; and with WEISBACH'S account of the low and small forehead of the German female.

† The measurements of the three portions of the arch in different nations given by Dr. BARNARD DAVIS in his 'Thesaurus Cranium,' the elaborate description of his magnificent collection do not altogether corroborate these statements, especially with regard to the Chinese. But the object of the present paper being tentative, written as it has been rather in the hope of pointing out explicit methods of comparison than to dogmatize on a slender basis with regard to characteristics of particular nations, it has been deemed advisable rather to add this caution than to alter the statement in the text.

‡ These are the measurements termed by CARUS height of the anterior, middle, and posterior cranial vertebra CARUS, Grundzüge einer neuen Cranioscopie, p. 16.

in the length of arc while the chord remained unaffected. The measurement has not proved necessary for the purpose for which it was undertaken, but it has served to lay bare some points of interest. In most of the nationalities examined, including the German, Scotch, Irish, Greek, Negro, Kafir, Maori, and Australian, the ratio of the

	Proportion to parietal arc of				Proportion to parietal chord of			
	Occipital arc.		Frontal arc.		Occipital chord.		Frontal chord.	
	Average.	Extremes.	Average.	Extremes.	Average.	Extremes.	Average.	Extremes.
2 Esquimaux .....	98	100 97	108	109 108	88	90 87	107	110 104
8 German .....	94	102 83	104	126 91	82	90 75	100	120 90
9 French .....	94	118 85	102	118 93	87	97 80	103	115 97
8 Scotch.....	93	102 86	100	109 92	85	94 81	99	107 90
9 Irish .....	91	110 71	100	107 94	80	91 67	97	102 91
4 Kafir .....	91	97 85	100	104 94	84	90 77	97	102 91
7 Negro .....	88	108 73	100	110 87	82	100 68	97	107 86
5 Greek .....	88	102 78	98	108 92	81	88 73	95	104 91
3 Hindoo .....	87	88 87	100	110 94	84	88 81	101	114 95
2 Peruvian.....	85	87 83	100	110 90	90	95 85	107	117 97
2 Kanaka .....	84	85 84	94	102 87	81	83 80	94	102 86
7 Australian .....	82	92 71	93	110 81	76	82 72	90	102 80
1 Maori .....	81	.....	90		74	.....	88	
6 Chinese .....	80	100 72	92	100 84	78	91 72	92	100 86

occipital to the parietal chord is considerably less than that of the occipital to the parietal arc; and the ratio of the frontal chord to the parietal is also a little less than that of the frontal to the parietal arc. This means that in those nations the frontal part of the arch is more curved than the parietal, and the occipital more curved than either. In the French, according to the average of the nine skulls examined, the ratio of the frontal to the parietal chord is slightly greater than that of the frontal to the parietal arc; and on looking at the measurements of the individual skulls, it is seen that this is the case in four instances, that in two instances the proportions of the chords and arcs are the same, and that in the remaining three instances the figures indicating the proportionate lengths of the frontal chords are only very slightly smaller than those of the frontal arcs. Therefore, so far as these nine skulls bear evidence, the French differ from the nations above mentioned in having the parietal region of the arch as much curved as the frontal, or more so. In this the French skulls agree with the Hindoo, the Chinese, and the Kanaka; but these three nations present the additional peculiarity that in the occipital region the

proportional length of the chord approaches very near to that of the arc, so that the amount of curvature in the three regions in these nations is nearly equal. The Chinese skull from the Edinburgh Collection is an exception to this statement; but the calculations made from LUCÆ'S drawings agree completely one with another (p. 123). This same phenomenon of near correspondence of the proportional lengths of the chords with the lengths of the arcs of the different parts of the arch is a marked characteristic of the skulls of infants; we have therefore here another interesting child-like peculiarity of the Chinese skulls. Both the Peruvian skulls present the peculiarity of having the parietal region distinctly more curved than either the frontal or occipital, and in this they agree with the compressed and flattened American skulls; but how far the peculiarity is referable to the slight compression which the Peruvian skulls have both to a certain extent undergone is an open question. It may be interesting to note that measurements taken from the cast of the Tartar skull described by Professor HUXLEY\* as an example of extreme brachycephalism give 93 and 111 as the proportions of the occipital and frontal arcs to the parietal estimated at 100, and 92 and 112 as the proportions of the occipital and frontal chords, thus indicating an equally distributed curvature. Dolichocephalism and brachycephalism will be treated of in a subsequent page; meanwhile the writer may be allowed to state, without further explanation, that he believes this equally distributed curvature to be a brachycephalic characteristic.

A further and more detailed acquaintance with the curves of the arch may be sought by examining the angles formed by lines passing from point to point; and this will be now attempted.

*Angles expressive of the form of different parts of the arch* (General Table, columns 16 to 24). *Young skulls*.—In the fœtus and in infants the forehead springs at a considerably greater angle from the roof of the orbit than in the adult. Whereas the average orbito-frontal angle varies in different nationalities from 77° to 83°, and only one adult skull (46) has an orbito-frontal angle exceeding 90°, in the fœtal skulls and those of infants the same angle exceeds 90° in all except two instances, and in one infant it even reaches 104°. In childhood it suffers a little diminution, but principally it gets smaller at a later age, when also the orbit is deepened and the frontal sinus enlarged by the growth forwards of the upper part of the face, as will be subsequently shown. Thus also the orbito-frontal angle is generally larger in females than in males.

The frontal bone, in the progress of development, changes its curve not only where its orbital and frontal plates meet, but also in the course of its frontal plate; for the mid-frontal angle appears to get smaller in the passage from fœtal or infantile life to childhood, and again enlarges in the passage to the adult state; or, in other words, the bone becomes more curved in childhood and is again flattened in subsequent growth. In the four-months' fœtus the midfrontal angle is of an average adult size, in the two five-months' fœtuses it is decidedly smaller, in the seven-months' fœtus it is again larger, and in the eight-months' fœtuses it is of a size which would be very flat in the adult. These varia-

\* *Loc. cit.*

tions may be to some extent the result of mere individual peculiarities of the few skulls examined, but they agree with what is observed with the unassisted eye; for it is clear enough, when attention is attracted to the circumstance, that a fœtus eight months old has a flatter forehead than a fœtus five months old, or a child a few months after birth. The skulls of infants present great differences in this respect, but the six skulls of children from  $2\frac{1}{2}$  to 10 years old, have all got the midfrontal angle of a size which would be accounted small in the adult, and therefore indicating a greater curvature than usual.

As is the case with the frontal region, so also with the parietal and the part of the occipital above the tuberosity; the curve does not go on uniformly increasing or diminishing, but at one period of growth is flattened and at another more convex. The parietal angle, indicating the curve of the mesial edges of the parietal bones, is as large in the three fœtuses of the fifth and seventh month as it is in the adult, whereas in the fœtus of the fourth, and in the two of the eighth month it is remarkably small; at birth it has begun again to enlarge, and in childhood apparently it reaches the condition which remains in the adult. On an average the parietal angle is smaller in women than in men, the feminine form in this respect resembling that of the young skull. The mid-occipital angle, which indicates the curve of the subcutaneous part of the occipital bone, is flatter in five of the six fœtal skulls than in any of the six infant skulls, and of a size very common in the adult, whereas both in infancy and childhood it is of an average size much smaller or more prominent than in the adult. It is to be observed, however, that the flattening of this part of the skull in the passage from childhood to adult life is no doubt due, in part at least, to the laying on of additional substance in the neighbourhood of the tuberosity.

In perfect keeping with the changeful development of the curves just mentioned is the variation at different ages of the transverse curve of the calvarium between the parietal eminences; for, as is palpable to the most careless observer, that curve rises rapidly towards the middle line in the fœtus, becomes in childhood remarkably flat, and again rises in the middle line as growth proceeds. This will be again referred to.

Of the remaining angles illustrating the curvature of the arch, the most important to be noticed in connexion with the form of the young skull are the fronto-parietal angle and the angle of the tuberosity, both of which are decidedly flatter in the infant than in the adult. The fronto-parietal angle is also flatter in women than in men. The occipito-parietal angle is rather more prominent in the infant skull than in the adult. The postforaminal angle is very variable, both larger and smaller numbers of degrees occurring in the fœtuses, infants, and children than in any of the adult averages. The postforaminal angle of the female is on an average smaller than that of the male; but this is to be accounted for by the lighter weight of the female skull, making it less liable to be affected by the gravitation changes described in the next paragraph. It may be stated generally with regard to the infant skull, that the flatness of the fronto-parietal angle and of the tuberosity, and the rapid curvature of the parts of the arch between these two angles, together with the great development of the parietal region of the arch, and

the shortness of the base, are the circumstances which give the characteristic outline to its profile.

*Elderly skulls. Gravitation changes.*—It is a well recognized fact that the skull continues to undergo change of form after adult life is reached. LAVATER in the general appearance of the head, and FRORIEP\* in the skull, depict the retreat of the forehead characteristic of old age, but the precise nature of the change and the causes on which it depends have not been recognized. The changes referred to result entirely from the operation of mechanical causes, and consist in a yielding of the skull in consequence of its own weight. Precisely as the apparently solid glacier flows down its valley at a rate too slow to be appreciated by direct observation, so the skull falls gradually down by its own weight and that of the contained brain. The condyles of the skull are supported on the vertebral column, and by the process of gradual yielding the basal part of the skull is driven in, from the occipital tuberosity behind, to the fronto-nasal suture before. Thus the postforaminal angle is flattened out, while the angle of the tuberosity and the orbito-frontal angle are made smaller. At the same time the skull is increased in breadth, being made to bulge out at the squamous suture; this bulging being partly produced by a forcing open of the angle between the squamous and petrous parts of the temporal bone, and partly by the depression of the outer end of the petrous part to a lower level than its inner end. This lateral bulging is very characteristic, and ought not to be lost sight of by the artist in representing old age. In the production of these alterations of form it is plain that the cooperating causes are weight of the skull and its contents, softness of the bone, and lapse of time; therefore the larger the skull the more likely they are to be developed in a marked manner; and if the bone be more than usually yielding they may be developed at an earlier age than usual, even though the skull be not remarkably large. This is probably the explanation of the very considerable gravitation changes in the skull of BURKE the murderer, who, although somewhat past middle life, was by no means an old man at the date of his execution. Most probably these changes begin in a slight degree in all skulls at an early period of adult life; and it may be the lot of some one who has better opportunities of investigating the subject than the present writer, by a comparison of a number of adult skulls of different ages, to demonstrate the changes of form which the skull undergoes in the passage from twenty to thirty, forty, or fifty years of age. The accompanying Table gives a list of the skulls from the study of which the above observations have been made; and if the angles given be compared with the corresponding angles of other skulls, they will illustrate the way in which by gravitation changes the base is driven in. In the German 29 the forehead appears to have escaped being bent back, and instead of its being so the parietal region has become flattened out.

\* FRORIEP, Die Charakteristik des Kopfes nach dem Entwicklungsgesetz desselben, 1845.



	Angle of tuberosity.	Postforaminal angle.	Orbito-frontal angle.
French 24 .....	124°	163°	77°
German 28 .....	122	158	76
German 29 .....	125	154	80
Old Officer.....	120	166	74
Corfu 45.....	120	153	75
Irish 51 .....	125	153	78
Irish 52 .....	130	150	75
Burke .....	120	166	76

A much more astonishing instance of driving-in of the base of the skull is seen in the anomalous skull (91) belonging to Professor THOMSON. In it the part of the occipital bone between the tuberosity and foramen magnum has not yielded, while the parts further forwards have given way to an astonishing extent. This may be accounted for by the great thickness of the occipital bone in this instance; or, if the theory be true that it is a baker's skull driven in by the weight of heavy trays carried habitually on it, it is likely to have happened that the pressure began to be applied after the superior and lateral ossifications of the occipital bone were united, and before synostosis of the elements of the base had been completed. These observations on this remarkable skull are, however, put forward subject to the criticisms of Professor THOMSON, in whose possession it is.

*National differences in angles connected with the arch.*—These will be most rapidly noticed by grouping the peculiarities of each nationality together. The writer has studied them with the aid of averages in which the sexes have been kept separate, and regard has been had to the skulls in which gravitation changes have taken place; but it will be sufficient to state the conclusions at which he has arrived, leaving the reader to verify them from the data in the General Table.

In the Scotch skulls the orbito-frontal angle is decidedly below average, that is to say, the forehead slopes more than usually back on the floor of the skull; also the skull rises more rapidly than usual behind the foramen magnum, and the angle at the occipital tuberosity is unusually flat.

The Irish, on the contrary, have the occipital bone extending very horizontally backwards from the foramen magnum, as indicated by the large postforaminal angle. They have the curve of the forehead unusually prominent, as indicated by the smallness of the midfrontal angle.

The Germans, like the Irish, have the midfrontal angle prominent; they have great curvature at the occipital tuberosity.

The French have the orbito-frontal angle decidedly smaller than even the Scotch; they have coronal flatness as indicated by large fronto-parietal angle, and at the back of the head bend rapidly at the tuberosity.

While in the different European nations the midparietal angle retains an average size of about 133°, the Esquimaux, Kafir, Negro, and Australian agree in having it larger,

a circumstance possibly connected with the length of base-line in these nations; that is to say, that the length of the arch being completed before the length of the base-line, the extremities of the arch are possibly separated by continued opening-out of the mid-parietal angle in the latest growth of the base. The Kafir, Negro, and Australian all have the orbito-frontal angle large, the Kafir having it remarkably so. The Kafir, further, has the midfrontal angle flatter than the Negro, otherwise the curves of these skulls, as exhibited by angles, are very similar.

In the Australians the curvature of the roof is very evenly distributed, as is indicated by the smaller than usual fronto-parietal angle in conjunction with the large midparietal angle; the midoccipital angle is prominent.

The two Kanaka skulls agree in presenting remarkable curvature both at the mid-parietal and occipito-parietal angles; and in both, but especially in the male, a slope backwards is given to the whole skull by the small orbito-frontal angle and the flat mid-frontal, and the unusually flat angle at the occipital tuberosity.

The Peruvian skulls are remarkable for the extreme flatness of the midfrontal and midoccipital angles, and extreme smallness of parietal and postforaminal angles. They have the orbito-frontal angle small.

The Hindoo skulls have the fronto-parietal and midparietal angles small, the orbito-frontal rather small, and the midoccipital angle flat.

The Greeks have the orbito-frontal angle large, the fronto-parietal small, the mid-occipital flat, and the postforaminal angle small.

The size of the orbito-frontal angle in different nations appears to be a matter of sufficient importance to demand some further consideration. Among the loose notions which are popularly current about the form of the skull, and which have been with too little care incorporated among the beliefs of scientific men, and been allowed to assume among them a more definite and erroneous shape than they have in the unscientific mind, is one to which allusion has already been made, that amplitude of forehead is a criterion of high development both in individuals and nations, and that nations of inferior intellectual development have low or retreating foreheads. The unscientific man in expressing such a notion considers nothing but external appearances, and his statements are not without a certain foundation of truth, for increased height and breadth of the whole cranium, and large proportion of arch to base are among the circumstances which may make the forehead well developed; but when ethnologists go the length of imagining that in the lower types of humanity there is a local deficiency in the frontal part of the skull, giving room for only a small development of the anterior lobes of the brain, they fall into an anatomical error, as the measurements of most characteristic skulls will serve to show. It has been already shown that the Kafirs, Negroes, and Australians have a great development of the orbital length, and now we have occasion to observe that in these same skulls, but especially in the Kafir, the forehead springs very erectly from the orbit. This may be seen by a comparison with European skulls.

In three Kafir males the average number of degrees of the orbito-frontal angle amounts

to  $84\frac{2}{3}$ ; in four Irish males, omitting from consideration the two which have undergone gravitation changes, it amounts to  $84\frac{1}{2}$ ; in three Greek, omitting both the skull which has gravitated and another (46) in which the orbito-frontal angle is anomalously large, it amounts to 83; in three German, omitting the two which have gravitated, it amounts to  $82\frac{1}{3}$ ; in two Australian, 82; in five Negro skulls, 81; in five Scotch males, omitting the Old Officer, it amounts to  $78\frac{4}{5}$ ; and in five French, omitting the Old Knight, it amounts to  $76\frac{2}{5}$ . Thus there are Kafirs and Irish at one end of the series, French and Scotch at the other, and Germans and Negroes in the middle.

Whatever of inaccuracy has been imported into the measurement of this angle by the choice of the optic foramen as the posterior limit of the frontal floor, instead of a point in the mesial plane, makes the conclusion with regard to the Kafir, Negro, and Australian all the more trustworthy; for in these races the tendency of the lesser wings of the sphenoid as they pass outwards is to rise more than in European skulls, and thus to raise the optic foramina more than usual above the level of their origin, which makes the estimate of the orbito-frontal angle less than if it had been measured on a mesial section. But, further, an examination of some of the skulls, tracings of the mesial sections of which have been preserved, will be of itself sufficient to show how little a large orbito-frontal angle is to be trusted as an index of a superior type of skull. The Negro skull 63, a skull of a very inferior type, and the Australian skull 73, which, though rather well developed for an Australian skull, is yet a thoroughly characteristic specimen of that race, have the orbito-frontal angle respectively  $83^\circ$  and  $82^\circ$ ; while the German skull 29, an extremely well-developed skull, has an orbito-frontal angle of  $80^\circ$ , and the young Scotch female skull 43, which, notwithstanding its defects, is a much more finely proportioned skull than Negro 63, has the same angle measuring only  $74^\circ$ .

*Deep frontal angle* (General Table, column 32).—The testimony obtained by measurement of the angle formed at the foramen opticum by lines from the fronto-nasal and fronto-parietal sutures, and which may be termed the deep frontal angle, corroborates the conclusion that a forehead retreating on the floor of the anterior cranial fossa is by no means a character of the least advanced races. Indeed a glance over the list of diagrams will show that a certain proportion exists between the deep frontal and orbito-frontal angles, so that it may be considered the normal condition at different ages and in different races for these angles to be together nearly equal to two right angles. The most extreme instances of the sum of the two angles falling short of  $180^\circ$  is the Carib skull 88, in which it is only  $167^\circ$ , the deviation being dependent in great measure on the largeness of the frontal sinus. The most extreme instances of the sum of the two angles exceeding  $180^\circ$  are the large British skull 92, in which it amounts to  $188^\circ$ , and the five-year-old skull 16, in which it reaches  $186^\circ$ ; and in both these it is the great length of the frontal part of the arch as compared with the orbital length which causes the deviation. The average sum of the orbito-frontal and deep frontal angles in adult male skulls, omitting, as before, those which have undergone gravitation changes, comes to about  $176^\circ$  alike in the Kafir, Negro, Australian, Hindoo, Greek, Scotch, French, and

Esquimaux skulls; but it rises to about  $180^\circ$  in the German and Irish, which have a high proportion of arch to base-line; and in the Kanaka, Maori, and Peruvian skulls it sinks to  $173^\circ$  and  $174^\circ$ .

The deep frontal angle gets regularly larger from foetal up to adult life, as the frontal bone gets larger in proportion to the rest of the arch; or, to put it differently, it may be said that the increasing length of the frontal bone pushes down the fore part of the ethmoid and bends it on the sphenoid.

*Area of the frontal, parietal, and occipital parts of the diagrammatized profile* (General Table, columns 40 to 46).—So far as the examination of angles and of measurements of arch and base has gone, the present inquiry has shown no reason for the belief that frontal development is more important or nobler than development of the other cranial regions; nor is any evidence to that effect to be got by comparing the areas of the different regions. The calculation of the areas has for the sake of simplicity been made on the angular figures produced by joining by means of straight lines the series of points already enumerated as selected for measurement. Thus the area of a trapezium has been measured in the case of the frontal region, a pentagon in the parietal, and a hexagon in the occipital region. The results are therefore only approximate, but they are sufficiently accurate for practical purposes.

It is remarkable that in the relative proportions of these three areas, no national nor sexual differences whatever are exhibited. Unfortunately the writer is unable to say how far this statement is applicable to the Chinese and Australian skulls, in which the parietal part of the arch was found habitually to predominate over the frontal and occipital parts; for LUCÆ's figures do not furnish sufficient details for making the calculation in the same way as it has been done in other skulls. But on comparing the average area in those nationalities of which three or more specimens have been measured, viz. Scotch, Irish, French, German, Greek, Negro, Kafir, and Hindoo, it is found that the variation in the occipital area is only 1.56 per cent., in the parietal area 1.19, and in the frontal 1.74 per cent., a result equivalent to no variation at all. This is the more remarkable as in the series of skulls examined, the variation among individuals in the occipital area reaches 11.98 per cent., in the parietal area 10.99 per cent., and in the frontal area 6.36 per cent. The Chinese skull 85 has the smallest proportion of frontal area in the whole series, on account of the shallowness of its orbits, and on the same account the synostotically deformed skull 89 has it nearly as small. Also among those which have the proportion of the frontal area smallest are the two female skulls, Irish and Scotch, 57 & 42, in which there is no spheno-parietal contact.

The same variability of the proportions of the three areas in individuals which is seen in the adult is observed also in young skulls. The figures expressing those proportions in the foetal and infantile skulls are almost all such as might be found in the adult; but the averages show a somewhat larger proportion of parietal, and a smaller proportion of occipital and frontal area. The difference, however, does not seem to be such as to account for the obvious predominance in bulk of the parietal region in young skulls, which probably depends most on breadth.

*Distance of the arch at various points from the base* (General Table, columns 33 to 39).

—To estimate the distance from arch to base in different parts of the mesial extent of the skull four diameters have been chosen, namely, a line from the level of the foramen opticum to the fronto-parietal suture, which may be termed the frontal depth, and three lines converging to the spheno-occipital suture from the midparietal point, occipito-parietal suture, and the occipital tuberosity, which may be termed respectively the parietal, occipito-parietal, and occipital depths. In comparing them the parietal depth has been chosen as the standard, not merely because it is the longest, but because, as may have been observed from what has been already stated with respect to the angles connected with the arch, it may be regarded as an axis behind and in front of which the arch of the skull expands in growth from birth onwards.

In the first four fœtal skulls the frontal depth is such as would be esteemed high in the adult, but in the two skulls of the eighth month it is low, and in the skulls of infants it is still lower; in childhood, however, it rises and appears to gain the adult proportion. The occipito-parietal and occipital depths are on an average slightly smaller in the fœtus than in the infant, and both, but more especially the occipital, increase in childhood.

These measurements, like those which have gone before, show that the sugar-loaf-like form of the infant skull is no mere mechanical result of compression during birth, but is prepared beforehand, and subsequently lost in the proper process of growth.

As in the case of other measurements, so also with those under consideration, the results in the adults of different nations are not altogether distinct at first sight; and it must be owned that on them alone a speculation could not be based with regard to the nationality of a particular skull; but by taking averages in those instances in which several skulls have been examined, national differences are indicated of a not altogether uninteresting kind. Comparing fourteen different races together (some of them represented, however, by only one or two specimens), and marking as high, moderate, or low the proportionate lengths of the frontal, occipito-parietal, and occipital depths as compared with the parietal depth, the following results are obtained:—

Proportion of the occipital, occipito-parietal, and frontal depths to the parietal depth.  
High proportions are marked *a*, intermediate *b*, and the lowest *c*.

	Occipital depth.		Occipito-parietal depth.		Frontal depth.	
	Average.	Extremes.	Average.	Extremes.	Average.	Extremes.
3 Hindoo .....	71	69 72 <i>c</i>	90	88 92 <i>c</i>	71	70 73 <i>b</i>
2 Peruvian .....	67	66 69 <i>c</i>	87	87 88 <i>c</i>	67	66 69 <i>c</i>
2 Kanaka .....	70	68 72 <i>c</i>	92	91 94 <i>c</i>	67	66 68 <i>c</i>
5 Greek .....	74	71 78 <i>b</i>	91	87 95 <i>c</i>	72	70 75 <i>a</i>
1 Maori .....	74	<i>b</i>	92	<i>c</i>	72	<i>a</i>
2 Australian .....	76	76 77 <i>b</i>	94	94 94 <i>b</i>	72	71 74 <i>a</i>
8 German .....	76	73 82 <i>b</i>	93	90 97 <i>b</i>	72	69 77 <i>a</i>
4 Kafir .....	76	70 82 <i>b</i>	95	93 98 <i>b</i>	73	70 78 <i>a</i>
7 Negro .....	77	68 85 <i>a</i>	95	92 100 <i>b</i>	70	66 74 <i>b</i>
9 French.....	76	71 80 <i>b</i>	93	89 98 <i>b</i>	71	67 78 <i>b</i>
8 Scotch.....	75	68 81 <i>b</i>	94	90 97 <i>b</i>	70	68 75 <i>b</i>
9 Irish.....	79	75 86 <i>a</i>	97	92 100 <i>a</i>	71	65 76 <i>b</i>
1 Chinese .....	77	<i>a</i>	98	<i>a</i>	68	<i>c</i>
2 Esquimaux .....	77	76 78 <i>a</i>	96	96 96 <i>a</i>	72	72 73 <i>a</i>

The Peruvian and Kanaka have all the three lines in small proportion to the parietal depth, and the Hindoo skulls only differ in having a greater frontal depth. The Greek skulls and the Maori resemble these only in the short occipito-parietal depth, but have the forehead high and the occipital tuberosity moderately projecting. The single Chinese skull is deficient in frontal depth, but is full behind. The Esquimaux have all three lines well developed as compared with the parietal depth, which means that the parietal depth is deficient, a consequence of the flatness of the parietal part of the arch formerly alluded to. The French and Scotch skulls have the occipital, occipito-parietal, and frontal depths all moderately developed in proportion to the parietal depth; the German, Kafir, and Australian skulls differ from them in having the frontal depth comparatively great, and the Negroes in having the occipital depth greater, while the Irish have not only the occipital, but likewise the occipito-parietal depth great. Probably the most important part of these results is that which relates to the Peruvians, Kanaka, Hindoos, and Greeks, as it bears on what will fall to be advanced in considering the proportion of height to length.

*Height* (column 72).—The height of a skull is estimated by different writers in various ways. Von BAER measures it from the plane of the foramen magnum to the most distant point of the vertex\*. Mr. HUXLEY has preferred a line with definite termini, and

\* *Crania Selecta*, p. 4.

measures from the fronto-parietal suture in the mesial plane to the front of the foramen magnum\*, thus making the line of height agree as nearly as possible with that which he has adopted from Mr. BUSK† as expressing vertical direction, namely, a line from the fronto-parietal suture to between the openings of the ears. The present writer, however, appreciating, as Mr. HUXLEY has also done, that some skulls appear to stand vertically over the base while others slope upwards and backwards, has sought for a line the inclination of which will vary with the slope of the skull; and believing that the best criterion of that slope is the direction of the line of frontal depth, he has measured the height of the skull by a line passing upwards from the front of the foramen magnum parallel to the frontal depth. This line has the disadvantage in the present inquiry that its upper extremity does not exactly correspond with any of the measured points laid down in the diagrams, but the possibility of error from this source has been found to be very slight.

*Proportion of height to frontal depth* (column 74).—The proportion which the height measured as now stated bears to the frontal depth varies very much in different individuals; but, like steepness and levelness of the base, on which to some extent it is dependent, it is not a matter apparently of national distinction. It may, however, be remarked that those nationalities in which the parietal depth was great in proportion to the occipital, occipito-parietal, and frontal depths, have also a high proportion of height to frontal depth.

The question arises, how far excess of the line of height over the line of frontal depth depends on rise of the roof of the skull, and how far on sinking of the base; and this may be determined by examining the relation borne to the line of orbital length by the line uniting the midparietal and fronto-parietal points. This line, which is always cut by the line of height, sometimes, as compared with the line of orbital length, rises five or six degrees as it passes backwards, sometimes falls as much, but on an average and much more frequently is parallel with it in the adult. In the infant it rises greatly and most characteristically as it passes backwards; when the gravitation changes set in, they tend to make it fall; and in the compressed American skulls 95 and 96, and even in the French skull 27, which has probably been accidentally compressed by a head-dress in the manner described by GOSSE‡, it rises enormously behind, as it does in no natural adult form. Thus it appears that in the normal adult skull the excess of the line of height over the frontal depth is dependent almost entirely on sinking of the base, but that in the infant and in artificially deformed skulls it depends in great part on rise of the roof. The conditions in the base of the skull which increase the excess of the line of height over the frontal depth are length of the foramino-optic line and greatness of the angle between that line and the line of frontal depth, which of course involves steepness of the base. Also, the proportional excess is increased by absolute shortness

\* Journal of Anatomy and Physiology, November 1866.

† Natural-History Review, October 1862.

‡ Déformations artificielles du Crâne: Paris, 1855.

of the frontal depth, since the absolute excess of height produced by sinking of the base then forms a greater proportion of the whole frontal depth. Thus in the skull of the Idiot, 94, the greatest proportion in the whole collection is found, and in the Carib, 88, it is nearly as great.

*Length* (column 71).—As in the estimation of height, so in that of length, it seems advisable to make use of a somewhat different measurement from that usually adopted; for it is scarcely accurate to compare, as is generally done, diameters which do not pass between corresponding points, and which have nothing necessarily in common except that they happen in differently shaped skulls to be the points furthest asunder. The measurement of length in the present Memoir has therefore been made from the mid-occipital point to the fronto-nasal suture, the midoccipital point being usually the most prominent part of the back of the head, and the fronto-nasal suture being chosen in preference to the glabellar prominence, because the glabellar prominence is exceedingly variable, and its development is of no importance as regards the general shape of the skull.

*Proportions of height and breadth to length* (columns 73 & 76).—By assorting the skulls of different nations according to the proportion which the height bears to the length, a highly natural arrangement results, those skulls being brought together for the most part which are similar in general form. Thus the Peruvian, Hindoo, and Kanaka skulls, which were associated in respect of the comparative distance of different points of the arch from the base, are again placed together, and a just and well-marked distinction is made between the Kafir and Negro, the French and German, and the Scotch and Irish. When the same groups of skulls are arranged according to the proportion of breadth to length, the result appears to be less satisfactory.

Proportion of Height to Length.			Proportion of Breadth to Length.		
	Average.	Extremes.		Average.	Extremes.
2 Peruvian .....	85	83 88	1 Peruvian .....	98	
3 Hindoo .....	83	82 84	8 German .....	86	84 92
1 Maori .....	81		1 Chinese .....	83	
2 Kanaka .....	78	78 78	9 French.....	82	80 90
1 Chinese .....	77		3 Hindoo .....	81	79 84
5 Greek .....	77	75 82	7 Scotch .....	80	77 85
4 Kafir .....	76	74 81	5 Greek .....	80	76 89
7 Scotch.....	76	72 78	1 Maori .....	77	
9 French.....	75	68 84	2 Kanaka .....	77	77 78
2 Esquimaux .....	74	74 75	2 Esquimaux .....	77	75 79
7 Negro .....	74	71 78	9 Irish.....	77	74 82
2 Australian .....	73	73 74	4 Kafir .....	73	70 78
8 German .....	72	69 76	7 Negro .....	72	68 75
9 Irish.....	71	65 75	2 Australian .....	71	71 72



We find certainly the Peruvian at one extremity of the series, and the Kafir, Negro, and Australian at the other, which seems a natural arrangement; but the German skulls, placed next to the Peruvian, have no resemblance whatever to that form beyond the mere matter of proportional breadth, while on the other hand they have much resemblance to the Irish skulls which they are far separated from. The Kanaka, also, should come near the Peruvian rather than be associated with the Irish skulls, with which they have not the slightest affinity. The tendency of recent writers has been greatly to exaggerate the importance of breadth of skull as a distinguishing race character; and while AEBY\* would divide skulls according to their breadth into two great groups, the stenocephalous and the eurycephalous, other writers have likewise given an enormous importance to breadth by estimating dolichocephalism and brachycephalism by nothing else than the "cephalic index." An inquiry into the origin of these terms may serve to show how objectionable this is.

The point which mainly struck the attention of RETZIUS was that certain skulls had less development and posterior projection of the occipital bone than others, and on that account were shorter from before backwards than they; he therefore termed those skulls brachycephalic, and others dolichocephalic. But to get a criterion of proportional length or shortness, it was necessary to select some measure with which to compare the length, and for this purpose RETZIUS selected the breadth; but he does not appear to have based his statements with regard to the dolichocephalism or brachycephalism of different nations on detailed calculations of the proportion of breadth to length in individual skulls; there is no evidence that he did so, and in his letter to Professor DUVERNOY, in 1852, he expressly states that he does "not as yet wish to determine fixed measurements to distinguish them, but that ordinarily the longitudinal diameter of the dolichocephalous surpasses the breadth about a fourth, while in the brachycephalous the difference varies between a fifth and an eighth. But *the most distinctive characters* are:" he proceeds (the italics being his); and forthwith he lays down seven distinctions, not one of which is founded on the proportion of breadth to length, but of which the fifth consists in the height as compared with the length†.

In the end of the same year, in his letter to Dr. NICOLUCCI, he enumerates nine distinctions, the first of which is that in the dolichocephalous skulls the longitudinal diameter surpasses the transverse by about one-fourth, while in brachycephalous skulls it surpasses it by about one-fifth to one-eighth. Thus it appears plain that while M. DUVERNOY'S French taste for precision led RETZIUS into fixing certain proportions of length and breadth as characteristic of his two great classes of crania, RETZIUS never allowed himself to forget that the importance of his division lay in the classes being distinguished by a number of different characters, a circumstance well appreciated by the editor of his works, in his note on the letter to Dr. NICOLUCCI. But the effect of the subdivisions

\* Schädelformen des Menschen und der Affen, noticed in HENLE'S Bericht, 1867.

† Ethnologische Schriften von Anders Retzius, p. 118.

introduced by BROCA and others\* has been to convert, in the attempt at precision, a natural classification into one as artificial as the Linnean system in botany.

The superiority of RETZIUS'S point of view over the more recent one is well illustrated by what has taken place with regard to German skulls. WELCKER, writing from Halle, has pointed out the prevalence of a very high cephalic index in Germans, and ECKER has shown that in the South Germans it is still more remarkable; and on that account they throw those skulls into the brachycephalic group, and in this are followed by others; while GUSTAVE RETZIUS in defending the opinion of ANDERS RETZIUS, whose works he edits, labours to show that WELCKER'S estimate of the cephalic index in the German skull is too high. The measurements of the eight German skulls given in this memoir support WELCKER'S view that the German cephalic index is high, some of them, perhaps South Germans, being extremely broad; but they are all of them in their antero-posterior mechanism completely dolichocephalic in character. Their height compared with their length is low, and this is true of the broadest of them; they have the occipital squama prominent, and the tuberosity particularly so; and the arch of the profile, instead of sinking "precipitously" in the region between the parietal eminences, "forms an oval curve from the forehead to the occipital protuberance," all which are mentioned by RETZIUS in his letter to DUVERNOY as characteristics of the dolichocephalic skull, and are circumstances which, apart from any such historical consideration, point out the propriety of associating the German with dolichocephalic forms.

Sandwich-Islanders and New-Zealanders were both considered by RETZIUS as brachycephalic†. The description which he gives of a Sandwich-Island skull applies perfectly to the two skulls of the Kanaka race presented by Dr. BARNARD DAVIS to Mr. GOODSIR, and used in the preparation of this Memoir. Had RETZIUS classified according to a numerical rule, he would have had no difficulty in settling the place of any specimen; but he sought a natural classification which would take into account the whole character of the skull, and therefore he was "at first somewhat doubtful about the right place" of his Sandwich-Islander, and the thoroughly accurate decision to which he came was arrived at notwithstanding "the considerable length compared with the small intermastoid distance"‡. The comparison which he makes between the Sandwich-Islander and the New-Zealander is quite borne out by the diagrams of the two Kanaka skulls and the Maori skull now before us. His words are, "compared with a New-Zealander's skull, this skull (the Sandwich-Islander's) shows much agreement therewith, but is distinguished from it especially by the compression referred to in the lower part of the occipital bone. The occipital bone in the New-Zealander is almost quite flat and more

\* THURNAM, *Ancient British and Gaulish Skulls*, p. 50; and LAING and HUXLEY, *Prehistoric Remains of Caithness*, p. 84.

† *Ethnologische Schriften*, pp. 65 and 66.

‡ Dr. BARNARD DAVIS, in his '*Thesaurus Craniorum*,' vindicates the decision of RETZIUS on the ground of the proportion of breadth to length, the average of 116 Kanaka skulls of both sexes having given the proportional breadth as .80: it is noticeable, however, that the 64 males gave the proportion .79, which falls short of the arbitrary limit of brachycephalism.

sloping forwards than perpendicular." This is brought out in the diagrams by the large size of the angle of the tuberosity in the Kanaka skulls and its small size in the Maori. In addition to this difference and connected with it, must be noticed the large orbito-frontal angle and small midfrontal angle of the Maori, contrasting with the small orbito-frontal and large midfrontal angle of the Kanaka; for all these differences are summed up in this, that the arch in the Kanaka is pushed back over the base-line, and in the Maori is pushed forward.

It is to be regretted, however, that the same considerations which led RETZIUS to include the Sandwich-Islanders in the brachycephalic group did not lead him to admit the Hindoos also. For although the Hindoo skull is certainly dolichocephalic, according to the criterion derived from proportion of breadth to length, it is nevertheless short and high, and possesses the peculiarities of occipital bone characteristic of brachycephalic skulls, namely, commencement of the upward slope immediately behind the foramen magnum, flatness of the subcutaneous portion, and indistinctness of tuberosity, to which may be added almost constant want of symmetry in the occipital plate. It has greater height of forehead and greater proportion of total height compared with length than the Kanaka, and has more of the characters of the brachycephalic skull than the New-Zealander. The affinity of the Hindoo skull with the brachycephalic group was well brought out by the comparison of the parietal with the occipital, occipito-parietal, and frontal depths. Reverting to that comparison, it may be said that the small proportion of the occipital, occipito-parietal, and frontal depths to the parietal depth, together with the flatness of the midfrontal angle, in the short-headed Americans and Sandwich-Islanders shows a brachycephalism dependent on a natural antero-posterior compression of all the regions of the skull, and not of the occipital region only: from these the Hindoos differ only, as regards profile, in having a slightly higher forehead, while the Maori and the Greeks have the forehead both high and prominent, and have the occiput more prominent at the tuberosity. The Maori and Greek forms may be looked on as links between complete brachycephalism and the dolichocephalism of the negritic races and the west of Europe respectively.

Of course, this allusion to the Greek skull is to be held as merely referring to them as they are illustrated in the few examined. While the occurrence of brachycephalic skulls among the Greeks is indubitable, it is not to be forgotten that the dolichocephalic form has been suggested as the normal one in that nation; but it may be allowable to suggest the possibility that while the proportion of breadth to length may be variable, the profile view may perhaps adhere to the brachycephalic type. Of the five Greek skulls measured, only one has a dolichocephalic profile, and in that instance it is, as will be shown, the result of idiosyncrasy.

If it be too late now to restore the terms dolichocephalic and brachycephalic to a broader meaning than has latterly been given to them, and if skulls must needs be grouped according to the indications of some single proportion, the proportion of height to length will probably be a better basis on which to proceed than the proportion of

breadth to length. The short-headed Americans, the Polynesians, the Hindoos, the New-Zealanders, and the Greeks may well be contrasted with the Germans, the Irish, the Australians, and the Negroes, the one set being high and the other low in proportion to their length: and if the division cannot be made distinct without the use of Greek nomenclature, the one group may be termed *hypselocephalic*, and the other *tapeinocephalic*. But the truest expression of the facts will be obtained by instituting a subdivision of the brachycephali of RETZIUS under the name of *angustiores*, to which shall belong the Hindoo, Sandwich-Islander, and New-Zealander, probably the Greek, and possibly the Chinese. The mere establishment of such a division would set on permanent record that the brachycephali have more than one character. But whatever system of classification and nomenclature be determined on, it will always be artificial to associate with proportionally lofty skulls, like the brachycephalic Americans, low-lying skulls with dolichocephalic profile, such as the Germans, because they happen to have a cephalic index above 80°. These might be termed dolichocephali *latiores*.

*Position of greatest breadth* (see the diagrams).—The position of greatest breadth in well-developed skulls is always near the squamous suture, usually towards the place where it descends posteriorly. In ill-filled savage skulls it lies a good way up the parietal bone. By an ill-filled skull it is meant to express the condition of a mesial and two lateral ridges on the roof, with flatness of the adjacent surfaces. This ridged condition is a reversion, so far, to the infantile form, in which also the point of greatest breadth is placed high up; but the infant soon loses the ridged condition, and in childhood the roof of the skull becomes flatter than it is in the adult\*. Probably the point of greatest breadth descends at this period (as in skulls 14, 15, & 16), and afterwards reascends temporarily (as in 17 and 18) when the mesial part of the roof begins again to rise, then lastly descends a second time as the bones become more uniformly convex in the latest expansion of the brain; for, as has been pointed out by SCHAAFFHAUSEN†, breadth of skull goes on increasing up to adult age, although the permanent length is reached already at the seventh or tenth year. Possibly the rise in the roof after its flat condition in childhood, as well as whatever temporary reascent there may be in the point of greatest breadth, may be explained thus, that the closure of the frontal suture, while the sagittal suture remains open, imposes a limit to the lateral expansion of the skull, and the inner margins of the parietal bones continuing to grow, at the same time that they are kept together by the connexions of the parietals with the frontal and occipital, and being pressed on by the growing brain below, are forced upwards and produce the mesial elevation, partly by rotation of the parietal bones on their inferior margins, and partly also by unbending them, in which they are assisted by the continuing increase in the breadth of the base of the skull‡. While these changes are taking place, and after they have

\* The persistence of this flatness in the female is referred to at p. 164.

† HENLE, KEFFERSTEIN, und MEISSNER'S Bericht for 1865, p. 73.

‡ Professor WYMAN in his recent "Observations on Crania," republished from the Proceedings of the Boston Society of Natural History, vol. xi., in writing about the much discussed variety of synostotic skull called sea-

ceased, the surfaces above and below the lateral ridges are rounded out in well-filled skulls; but in ill-filled savage skulls that rounding-out fails to take place, and thus there is the more prominent mesial ridge and the higher position of the point of greatest breadth. The rounding-out of the sides of the skull which occurs from the latest expansion of the brain is followed by that which is brought about by gravitation, as already described, and thus the increase in breadth does not necessarily cease on arrival at adult age, but may continue through life. Another position of the point of greatest breadth, indicating a more degraded form than that in which it is placed high on the parietal, has only been met with in one skull in the list, that of the Idiot. In that skull the greatest breadth is between the mastoid processes, as it is in the Gorilla and Chimpanzee, a condition resulting from the poor development of the arch of the skull.

*Radial measurements and position of the ear* (columns 47 to 63, and 69 and 70).—As it is impossible on the living subject to obtain measurements extending from points in the arch to points in the base, it would often be convenient to obtain information as to cranial configuration by means of measurements radiating from the external auditory meatus, like those proposed by Mr. BUSK\*. In the present instance the postauricular depression has been chosen for convenience instead of the centre of the auditory meatus as the starting-point, and the radius to the midparietal point has been chosen as a standard with which the other radii are compared.

The radial measurements serve well to display the differences between the infantile and the adult form of skull. In the infant the radii in front of the midparietal radius bear a smaller proportion to that radius than they do in the adult, and the difference is greatest in those furthest forward. Thus the proportional distance of the fronto-nasal suture from the postauricular depression, counting the midparietal radius as 100, is 70, and in the adult European about 83. To understand the significance of this difference, let the midparietal radius be estimated at 5 inches in the adult; and let the infant's head be magnified sufficiently to bring that radius to the same length in it, then the distance to the fronto-nasal suture in the adult will be 4.15, and in the infant 3.5, or .65 of an inch less than in the adult. Turning to the parts behind the midparietal point, it may be observed that the proportional distance of the occipito-parietal point from the ear is as great as in the Irish and Scotch skulls, and greater than in the French and German; the distance of the midoccipital point is slightly less than in the Irish

---

phocephalic, of which he describes various examples, the youngest of them being the cranium of a fœtus, remarks on the deficiency of height in the scaphocephalic skull, and asks why the compensatory growth required in consequence of the want of breadth does not take place upwards as well as in the longitudinal direction. The answer to that question may be gathered from the text. The height of the parietal region of the skull above the parietal eminences is obtained by the growth of the inner margins of the parietals, and when synostosis of those margins occurs, or when, as may be the case in some instances, there is but a single centre of ossification from which one 'biparietal' bone takes origin, not only is this source of upward growth lost, but the parts corresponding to the portions below the eminences of normal parietals are placed in a sloped instead of a vertical position.

\* Natural-History Review, October 1862.

and Scotch, equal to what it is in the French, and slightly greater than in the German ; the average distance of the occipital tuberosity is less than the average obtained in any instance in which two or more adult skulls are compared, with the exception of the Peruvian and Kanaka. If the adult proportional distance of the occipital tuberosity from the ear be taken as 62, then if the midparietal radius in both adult and infantile form be again estimated at 5 inches, the distance of the occipital tuberosity from the ear will be 3.1 in the adult and 2.8 in the infantile form, giving a difference of .3 of an inch. It would appear, therefore, comparing the infant skulls with the Scotch and Irish adults, that the shape of the arch is elongated in the passage to adult life by its anterior limb and, to a less extent, its posterior limb opening out round a part extending from in front of the midparietal point to behind the occipito-parietal suture. But if it be assumed that in all nations the infantile form is nearly the same (and on this point there is no accurate information), it would appear that the opening out of the posterior part of the arch is sometimes confined to the neighbourhood of the occipital tuberosity, for example, in the French, German, Hindoo and Greeks, while sometimes the whole arch may open up more and more from the occipital tuberosity forwards, for example, in the Kanaka and Peruvians.

National skulls, compared in respect of the radial distances, may be conveniently arranged in four groups.

The first group, with the radii both in front and behind the midparietal point short, includes the brachycephalic Americans, the Kanaka, and the Hindoos; and the French incline to that group.

The second group, with the radii both in front and behind the midparietal point long, includes the Australians, Esquimaux, and Negroes; and the Kafir lies on the borders between this and the next group.

The third group, with the radii behind long and those in front short, includes the Scotch and Irish, Chinese and Maori.

The fourth group, with long radii in front and short radii behind, includes the Greeks and Germans.

		Proportional length of radii from the ear, the midparietal radius being reckoned 100.						Actual length of mid-parietal radius.	
		Radii behind the midparietal			Radii in front of the midparietal				
		To occipital tuberosity.	Mid-occipital.	Occipito-parietal.	Fronto-parietal.	Mid-frontal.	Glabellar.		Fronto-nasal.
First group	4 Infants .....	56	75	86	95	91	83	70	3.05
	2 Peruvians ...	52	67	79	97	88	80	75	4.8
	2 Kanaka .....	54	70	82	100	96	88	81	4.8
	3 Hindoo .....	58	71	81	102	99	86	82	4.53
Second group	9 French .....	60	75	83	98	98	89	84	4.51
	2 Australian ...	65	79	86	104	104	96	90	4.3
	2 Esquimaux ...	63	79	87	103	103	95	89	4.4
	7 Negro .....	62	77	86	101	102	97	87	4.51
Third group	4 Kafir .....	63	77	86	101	100	93	85	4.65
	8 Scotch .....	63	79	86	99	96	85	81	4.6
	9 Irish .....	64	79	86	99	100	90	82	4.56
	1 Chinese .....	63	79	88	97	95	87	81	4.4
Fourth group	1 Maori .....	62	77	85	104	100	87	81	4.8
	5 Greek .....	59	71	82	103	102	91	86	4.56
	8 German .....	59	73	83	101	102	91	84	4.56

To the first of these groups there is scarcely any objection; for it must be admitted that the French skulls examined, with the exception of skull 24, exhibit a certain approach to the brachycephalic profile. But in the other groups there are great misplacements, sufficient to show that the radial measurements are not calculated by themselves to exhibit altitude and comparative development of the frontal and occipital regions. The key to this may be found on examination of the deviations in position of the postauricular depression as compared with the front of the foramen magnum. Thus the Kafir skulls exceed the French in height both actual and as compared with length, yet the radial measurements would lead to a contrary supposition; and the explanation is that in the Kafir the postauricular depression is one-fifth of an inch more elevated above the foramen magnum than it is in the French. So also the low-skulled Germans are associated with the rather high-skulled Greeks by the ear being a quarter of an inch lower in the German. The Maori and Greek are placed in opposition, the Maori seeming to have the anterior part of the arch weakly developed, and the Greek the posterior part weakly developed, but the postauricular depression is placed more than a fifth of an inch further forwards in the Maori than in the Greeks.

The circumstances which regulate the level of the postauricular depression as compared with the front of the foramen magnum are various. Yielding of the base, so as to make it transversely flat or concave as viewed from the exterior, obviously causes descent of the ear. Thus the gravitation changes of advancing years depress it, and the European skulls, with the exception of the Scotch, have it low, apparently because the base is not so massive and resisting as in races which have the base-line longer. Levelness of base-line is accompanied with a low ear, as in the French and German female skulls 25 and 34. Partly from this cause, and probably partly from slenderness of base, the ear is lower in the female than the male. The Germans have the ear particularly low, partly from slenderness of base, and partly, as may be supposed, from breadth; for growth of the lateral part of the brain will not only press outwards the lateral wall of the cranium but will depress its inferior limit. In all this there is evidence of what has been already suggested, that yielding from pressure is not a phenomenon confined to elderly skulls. Pressure is continually acting on the cranium, and produces most effect when the bones are least capable of resistance, precisely as has been shown by ENGEL\* to be the case with the bones of the face.

The variations of the position of the postforaminal depression backwards and forwards are more difficult to explain; but it is evident that this point corresponds very nearly with the outer extremity of the upper border of the pars petrosa, which limits posteriorly the middle fossa of the base of the skull; therefore the further back it is it indicates the greater elongation of the temporo-sphenoidal lobe and the portion of the brain above it, with corresponding shortening of the occipital lobe and cerebellum.

Seeing that radial measurements extending to the roof of the skull are vitiated as an indication of height by the variable elevation of the ear above the base, probably the

\* Das Knochengerüste des menschlichen Antlitzes: Vienna, 1850.

radial measurements most likely to be useful to the craniologist, in conjunction with measurements of other kinds, are those extending to the occipital tuberosity and fronto-nasal suture, indicating the comparative development of the anterior and posterior parts of the brain.

## II. THE FACE.

The most important points to be attended to in the measurements of the face are those affecting orthognathism and prognathism. The appearances so termed form the basis of a fundamental part of the classification of crania generally recognized, and in recent years it has been sought more explicitly to divide them by adding a third term and distinguishing opisthognathous skulls; yet it will not be hard to show that the opinions entertained by anatomists as to the causes which concur to produce these appearances are both vague and inaccurate.

So far as prognathism depends on the forward direction of the incisor teeth, or what may be designated prognathous dentition, it is simple enough and affords a stable foundation for classification; but besides that this is only one of the characters of prognathism originally enunciated by RETZIUS, the term is always considered as indicating projection of the face from underneath the cranium.

The broad contrast between the straight European face and the prominent muzzle of many savage tribes was evidently present alike to CAMPER in suggesting the facial angle, to BLUMENBACH in laying down the advantages of the norma verticalis, and to RETZIUS in distinguishing orthognathous and prognathous skulls; but these methods leave unexplained the nature of the anatomical peculiarities producing the appearances sought to be registered. VIRCHOW\* stepped forward, and estimating prognathism by the size of an angle, the "nasal angle," situated at the fronto-nasal suture and contained between two lines, one passing down to the nasal spine, and the other back to the posterior limit of the sphenoid bone, he laid down the rule that the shorter the base of the skull, and the more curved on itself, the more the face projected from underneath it. LUCAE†, taking the zygomatic arch as a horizontal line, and drawing a perpendicular to it from the fronto-nasal suture, estimated the retreat of the forehead and the projection of the face by horizontal lines drawn from points in them and cutting the perpendicular at different heights, and concluded that there was no relation whatever between the form or extent of the base of the skull and the projection of the face. Then WELCKER‡, choosing a nasal angle which differed from that of VIRCHOW in that the upper of its containing lines passed from the fronto-nasal suture back to the foramen magnum, put forward the statement that the base of the skull and the projection of the face were indeed in relation, but that the relation was precisely the reverse of that stated by VIRCHOW. LANDZERT§ agrees with VIRCHOW that the nasal angle and the angula sellæ exhibit an inverse ratio one to the other; but, appreciating that the nasal angle is no

\* Entwicklung des Schädelgrunde, 1867.

† *Op. cit.* p. 40.

‡ Wachstum und Bau des menschlichen Schädels, 1862, pp. 48 & 140.

§ Der Sattelwinkel und sein Verhältniss zur Pro- und Orthognathie, 1867.



true measure of prognathism, he recommends for that purpose LUCÆ's system of ordinates.

Both VIRCHOW's and WELCKER's nasal angles are objectionable, because the upper of the containing lines is a mere compromise between the directions of two portions of the base which lie at a very variable angle one to the other; while LUCÆ's method fails by being dependent on a line which is neither horizontal, as he and WELCKER suppose, nor gives any indication of the position of any part of the base; and the same objection holds good against setting the skull, for the determination of its prognathism according to Mr. BUSK's method, in such a manner that a line from the ear to the fronto-nasal suture shall be vertical.

VIRCHOW has been misled by his method. The skull of the Cretin 53 years old and that of the new-born Cretin figured in his work, do not get their peculiar characters of base, as shown in his plates, accounted for by the theory of "kyphosis" or increased curvature. The basilar process in both those skulls certainly lies at a less obtuse angle with the body of the postsphenoid, to which it is synostotically joined, than it does in the respective healthy skulls with which he compares them; but that circumstance is nearly made up for in the Cretin child, and in the adult Cretin is more than made up for, by the longitudinal axis of the sphenoid lying almost in a line with the cribriform plate of the ethmoid, instead of making the angle with it which is usual; so that a line from the fronto-nasal suture laid on the floor of the anterior cranial fossa and continued backwards, in the young Cretin touches, and in the old Cretin cuts the dorsum sellæ, while in the healthy skulls with which they are compared it lies far above that process. This altered relation of the sphenoid to the ethmoid accounts for VIRCHOW finding the "nasal angle" in the Cretins larger than in healthy skulls\*. Had he taken the floor of the anterior cranial fossa as the upper of the two lines containing the nasal angle, he would have found that the angle was smaller in the Cretin skulls than in the healthy, and that however prognathous the appearance which the Cretin skulls may have presented during life, that appearance was not to be accounted for by projection of the face from under the floor of the cranium, but in some other way.

WELCKER's statement that the greater the curvature of the base as estimated by means of the angula sellæ (Sattelwinkel) the smaller the nasal angle as he measures it, is undoubtedly true, but is uninformative; for it is self-evident that the more the basilar process is bent down from the direction of the floor of the anterior cranial fossa the more will the upper of the two containing lines of WELCKER's nasal angle be depressed, and that if in any skull the inclination of the basilar process were changed while the face was left untouched, the alteration in the angula sellæ and the nasal angle would only be different expressions of the one anatomical change. Seeing, then, that this nasal

\* This combination of what may be termed curving downwards of the presphenoid with curving upwards of the ethmoid is often met with in skulls of low type (see p. 169). It has occurred in the Australian skull figured by LANDZERT; and had that writer caused the upper limb of his angula sellæ to pass from the upper surface of the presphenoid forwards to the fronto-ethmoidal or fronto-nasal suture, instead of following the plane of the presphenoidal surface, his conclusions must have been materially modified.

angle is subject to such variations altogether independent of the position of the face, it is no wonder that, as WELCKER has observed, "the unprejudiced consideration of the whole skull in many instances exhibits a very different degree of prognathism from what the size of the nasal angle would indicate."

LUCAE is in one sense right in keeping altogether out of view the position of the base of the skull in seeking to estimate the amount of what is generally understood by prognathism and orthognathism; for it is evident that the relation of the face-bones to the base was never examined by any of the writers who attracted attention to the degree of prominence of the face; but, on the other hand, his method throws no light on the concurrent causes of the general appearances which they have noticed, nor does it furnish an accurate index of the extent to which either of the appearances is present. For example, it might not be difficult to find two skulls tolerably similar in appearance as seen in vertical mesial section, and which might be considered to have as thus seen the same degree of prognathism, but one of which would have the auditory meatus placed on a much higher level than the other. In such a case the difference in position of the auditory meatus would be accompanied with a difference in the disposition of the zygomatic arch such as would materially affect both CAMPER'S facial angle and the degree of prognathism as indexed by LUCAE'S method.

The foregoing remarks may serve to illustrate the uncertainty which invests the whole question of the varying relations of the face to the cranium, and may prepare us to investigate those relations in detail.

*The orbito-nasal angle* (column 24).—By this name may be designated the angle contained between two lines extending from the fronto-nasal suture, one to the optic foramen and the other to the tip of the nasal spine of the maxilla. The tip of the nasal spine is chosen rather than its root, because it is a more definite point, and because the nasal spine is a characteristic portion of the maxilla independent of the teeth. The orbito-nasal angle in the foetal skulls is of sizes such as are found in adults; but in the seventh and eighth month foetuses it is smaller than in those of the fourth and fifth months. In the infants at birth it has attained a greater size than it has either before or afterwards, but as childhood advances it becomes rather smaller than the adult average. Thus, if prognathism were to be taken as meaning projection of the face from underneath the floor of the anterior cranial fossa, infants would have to be considered as exhibiting the maximum of prognathism, notwithstanding that in them the face is far smaller in proportion to the cranium than it is in the adult. Observation on the living subject will fully verify in this respect the results of the measurements here given; for it will be readily seen that in infants and young children the sum of the orbito-frontal and orbito-nasal angles is much greater than in the adult. After birth the orbito-nasal angle diminishes apparently *pari passu* with the increase in the orbital length, dependent on the growth of the anterior lobes of the brain; but the orbital length is further increased at puberty by the enlargement of the frontal sinuses; and it is a remarkable and important fact that this is not accompanied with a further diminution of the orbito-nasal angle, but, there being about that time apparently a general growth of the face-bones,

the whole mesial extent of the face is brought forwards, and the nasal spine often even more than the root of the nose.

In the adult the range of variation of this angle is great, but is principally dependent on individual peculiarity, not at all on sex, and only to a limited extent on race. The extremes are  $79^\circ$  in the German skull 33, and  $103^\circ$  in the Hottentot skull 87. In almost all the nationalities of which several specimens have been examined, there is a range of variation of  $10^\circ$  or more, while the difference between the lowest and the highest national average is only  $7^\circ$ . The range of variation appears to be as great in the female as in the male; thus, for example, the largest and the smallest orbito-nasal angles found among the nine Irish skulls are in females. WELCKER's\* statement that women are more prognathous than men, like his other statement that opisthognathism specially accompanies brachycephalism, and prognathism dolichocephalism, is merely a geometrical result of his unfortunate choice of an upper bounding line for his nasal angle. He states that the female skull has "a greater tendency to prognathism as well as a less strongly bent tribasilar bone than the male;" thus the really valuable part of the statement resolves itself into finding the base more level in the female than in the male. This may be illustrated by reference to the French female skull 25, which in consequence of the levelness of its base would give a high figure for WELCKER's nasal angle, and yet has the orbito-nasal angle small, and is altogether in general appearance rather opisthognathous.

Considering the great individual variation and comparatively limited national variation of the orbito-nasal angle, and the exceedingly small number of skulls of any one nation which the writer has been able to measure, the results in the accompanying Table can-

	Average.	Extremes.	Range.	Average male.	Average female.
5 Greeks .....	$87\frac{2}{3}$	$80$ $94$	$14$		
9 Irish .....	$88\frac{1}{3}$	$82$ $93$	$11$	$88\frac{1}{3}$	$88\frac{1}{3}$
2 Esquimaux ...	$88\frac{1}{2}$	$84$ $93$	$9$		
8 German .....	$88\frac{3}{4}$	$79$ $94$	$15$	$89\frac{3}{5}$	$87\frac{1}{3}$
4 Kafir .....	$88\frac{3}{4}$	$87$ $92$	$5$	$89$	$88$
8 Scotch .....	$90\frac{3}{4}$	$84$ $99$	$15$	$90\frac{5}{6}$	$90\frac{1}{2}$
2 Kanaka .....	$91$	$85$ $97$	$12$	$85$	$97$
9 French .....	$91\frac{1}{3}$	$86$ $97$	$11$	$91\frac{1}{2}$	$92\frac{1}{3}$
3 Hindoo .....	$93\frac{1}{3}$	$88$ $98$	$10$		
7 Negro .....	$93\frac{1}{4}$	$85$ $102$	$17$	$93$	$95$
2 Australian ...	$94\frac{1}{2}$	$94$ $95$	$1$		
2 Peruvian .....	$94\frac{1}{2}$	$91$ $98$	$7$		

\* *Op. cit.* pp. 51 & 66.

not be considered as a sufficiently trustworthy exposition of the national averages of this angle; still it is curious to note that, such as they are, these results make the angle smallest in the Greek, Irish, and German, decidedly larger in the Scotch, and still larger in the French, which agrees well with the appearance of the features in those nations. Thus it will be generally admitted that prominence of face is a well-marked national peculiarity in the French; and probably no one will deny that the reverse condition is eminently characteristic of the Irish. There is enough in these results to lead to the anticipation that in an extended series of observations the orbito-nasal angle will furnish a marked character of distinction between the different European nations. But enlargement of this angle is certainly not the only source of the concrete phenomenon called prognathism. Any one handling the Kafir skull 68, the Esquimaux 77, or the Carib 88, would probably pronounce them decidedly prognathous; yet their orbito-nasal angles are respectively  $88^\circ$ ,  $84^\circ$ , and  $85^\circ$ . Another example is furnished by the diagrams of the Negro skulls 61 and 63, which are as similar as possible in the amount of their prognathism, as well as in many other particulars; and yet the one has an orbito-nasal angle of  $102^\circ$ , and the other an angle of only  $89^\circ$ ; but the sum of the orbito-frontal and orbito-nasal angles is in the one skull  $177^\circ$ , and in the other  $176^\circ$ , giving a similarity of external appearance notwithstanding great difference of structure.

*Length of face from fronto-nasal suture to nasal spine* (column 66).—The distance from the fronto-nasal suture to the nasal spine is not subject to much variation, the differences in length of face from the root of the nose to the mouth being chiefly dependent on variations in size of the incisor teeth and the depth of their sockets, while the amount allotted to nose, and the amount to upper lip, depend greatly on the extent to which the alar cartilages descend below the level of the nasal spine. It does not, however, do so altogether; and in the shortness of the distance from fronto-nasal suture to nasal spine ( $1.75$ ) in the skull of GEORGE BUCHANAN may be seen an indication of the shortness of his nose. This distance does not extend beyond  $1.65$  in any of the children's skulls examined; it would appear, therefore, that the growth of the upper jaw in length is completed at a later period, which agrees well with the evidence afforded by the orbito-nasal angle that the growth of the jaw forwards is not completed till the full development of the frontal sinus. This distance is shorter in the female than in the male; its shortness in the Australian skull 73 ( $1.65$ ) is probably an exceptional idiosyncrasy, for in five figures of Australian skulls by LUCEAE it varies from  $1.85$  to  $2.05$ .

*Naso-basilar angle and naso-basilar line* (columns 64 & 65).—It is only necessary under this head to record, for the sake of saving other observers needless trouble, that the distance from the sphenio-occipital suture to the nasal spine, and the size of the angle between a line joining these points and the line along the under surface of the basilar process of the occipital bone, have been carefully measured in the series of skulls examined in the hope that they might throw some light on the causes of prognathism. But the size of the angle is dependent in great measure on the steepness or levelness of the base of the skull as well as on the form of the face; and the length of the line is

affected by the size of the whole skull as well as by the proportionate size of the face and its projection forwards; and thus neither measurement yields results of much importance.

*Causes of prognathism.*—If the reader take into consideration the various points bearing on prognathism which have already been considered, he will easily convince himself that the causes of that appearance are not, as is usually supposed, confined to the form of the face. The statement of the case may not unfairly be put thus:—that a retreating forehead and projecting face are regarded as characters of a savage or degraded form of the human skull; but it has been shown that the result on the profile produced by that combination is exactly the same as what is produced by the combination of a vertical forehead with a non-prominent face, or, in other words, a large orbito-frontal angle plus a small orbito-nasal angle is equal to a small orbito-frontal plus a large orbito-nasal angle; and by studying the direction of the floor of the anterior cranial fossa which separates those two angles, it has been further seen that it is far from being true that the forehead in the ruder races of men slopes more back on the floor than in cultivated nations, and that it is by no means always the case in admittedly prognathous races that the orbito-nasal angle is larger than in orthognathous races. Therefore, although prognathism sometimes is the accompaniment of a large orbito-nasal angle, it remains to be explained how a skull with a small orbito-nasal angle may yet be prognathous, and why a skull with that angle large is not necessarily so.

The first thing to be noted in explanation is that in prognathous races skulls often are found which are not prognathous except in their dentition. But besides this there is another matter to be taken into account. The division of skulls into orthognathous and prognathous is simply an application of the *norma verticalis*, and a skull is judged of according to the apparent prominence of the face when it is laid on a flat table. Such apparent prominence may be made to disappear by placing a support beneath the occipital bone; and thus it is apparent that the form of the back of the head affects prognathism as estimated by the *norma verticalis*. The principal circumstance which acts in this way is the degree of cranial curvature; for it is evident that if the fore part of the skull be taken as fixed in position, the greater the curvature the lower will the back part of the base be brought. Two other causes, namely, shortness and levelness of the base, conspire when present along with deficient curvature to increase apparent prognathism: they are not necessarily or even usually present in prognathous races; but the flattened American skull 96 affords a good example of the combination alluded to producing great apparent prognathism with a rather small orbito-nasal angle. In the Esquimaux skull 77 an illustration is given of a prognathous appearance dependent on deficient curve, notwithstanding the great length of the foramino-optic line and the smallness of the orbito-nasal angle.

It ought further to be noticed that length of face, including dental sockets, will tilt up the fore part of a cranium laid on a table and produce apparent prognathism similar

to what deficient curvature would; and thus it happens that projection forwards and elongation downwards of the face are liable to be confused together in judging of prognathism. The Kafir skull 68 and the Australian 73 may be taken as illustrations of these two kinds of facial prominence. Not only in judging of dry skulls, but also with respect to skulls clothed with the integuments and during life, the elongation of the face downwards may be mistaken for projection forwards; for this seems to have been done by VIRCHOW in the instance of the adult Cretin head already referred to. So also the appearance simulating prognathism, extremely common in the rustic population of the west of Ireland, is certainly not the result either of prognathous dentition or large orbito-nasal angle, but reaches its maximum when there is a heavy dentition in the upper jaw, and the lower jaw is so small that the chin fails to come forward into a straight line below the upper incisors.

In column 67 of the General Table it has been sought to express by a single measurement, termed index-angle of prognathism, the gross amount of prognathism, whether dependent on projection or length of face, or on deficient cranial curvature. It is the angle between two lines, both starting from the alveolar process between the middle incisors, and one of them passing to the fronto-nasal suture, while the other touches the lowest part of the base in the diagram, which in most instances is the back of the foramen magnum, but in some fetuses is the front of that foramen. The angle exhibits a great deal of individual variation in the nations in which several specimens have been examined, the variation in the German skulls amounting to  $14^{\circ}$ ; still the order in which it arranges the nations is worth noting. The most orthognathous skulls are the Greek, and after them come Scotch, French, Irish, German, Kanaka, Hindoo, Esquimaux, Peruvian, Kafir, Australian, Negro, and lastly, most prognathous of all, the compressed and flattened Americans.

A much more precise comparison, however, than can be made either by this index-angle or by division of skulls into prognathous, orthognathous, and opisthognathous, may be made by distinguishing the different points which together combine to constitute prognathism.

*First.* Prognathous dentition can be easily detected with the unassisted eye.

*Secondly.* The size of the orbito-nasal angle should be distinguished.

*Thirdly.* The cranial curvature ought to be considered quite apart from the preceding characters, although the following may be taken in lieu of it.

*Fourthly.* As the curvature of the cranium is continued in the face, and in most characteristically prognathous skulls the facial part of the curve is unusually slight even when the proper cranial curve appears fully developed, it is well to take account of the whole curve which is expressed by the retreating angle contained between the long diameter of the foramen magnum and a line from the back of the palate to the alveolar process between the middle incisors. This may be termed the foramino-palatal angle.

*The foramino-palatal angle* (column 31) gives results not very dissimilar from those

given by the angle of cranial curve. It differs from that angle, however, in that apparently it is not affected by sex. The cause of this seems to be that while the cranial curve is greatest in the female sex, females have also shorter faces than males, and the one difference counterbalances the other. The arrangement according to the size of the foramino-palatal angle separates the European from other skulls more completely than the cranial curve does.

	Average.	Extremes.	
Esquimaux.....	198 <sup>0</sup>	189 <sup>0</sup>	and 207 <sup>0</sup>
Peruvian .....	199 <sup>1</sup> / <sub>2</sub> ?	191?	208
Kafir .....	201 <sup>1</sup> / <sub>2</sub>	193	216
Negro.....	202 <sup>3</sup> / <sub>4</sub>	197	212
Kanaka .....	202 <sup>1</sup> / <sub>2</sub>	195	210
Australian .....	204	202	206
Hindoo .....	206	201	212
Greek.....	206 <sup>2</sup> / <sub>5</sub>	202	213
Scotch .....	208 <sup>1</sup> / <sub>4</sub>	198	216
French .....	210 <sup>8</sup> / <sub>9</sub>	202	216
German .....	212 <sup>1</sup> / <sub>2</sub>	201	219
Irish .....	214 <sup>1</sup> / <sub>4</sub>	210	220

*Relations of the upper jaw to the ear* (columns 54, 55, 62, 63, & 68).—The line from the postauricular depression to the nasal spine is in many instances exactly equal to the line from the same point to the fronto-nasal suture; much more frequently it exceeds it, doing so to the greatest extent when the ear is high above the level of the foramen magnum and the elements of prognathism are present; while occasionally in the Irish, German, and Scotch skulls it falls considerably short of it. The worst fault of CAMPER'S facial angle is that the anterior line is rested on the glabella instead of the fronto-nasal suture, and thus an element is made to operate on its size which has really nothing to do with the conformation of either face or cranium, but is a mere local accident. If it be modified by drawing one line from the postauricular depression, and the other from the fronto-nasal suture, to meet at the nasal spine, an angle will be obtained which will vary according to the same circumstances as regulate the proportionate length of the lines from the postauricular depression to the fronto-nasal suture and nasal spine. On the whole, the absolute difference between these two lines is the simplest register of the information. Four circumstances influence the comparative length of these lines, as also the size of the facial angle now described; they are:—first, the height of the ear above the level of the foramen magnum; secondly, levelness or steepness of base, and the extent of the foramino-optic line; thirdly, the length of the face from the fronto-nasal suture to the nasal spine; and fourthly, the size of the orbito-nasal angle. The accompanying diagram (p. 160) makes these points clear, and also illustrates that a certain amount of projection forwards of the nasal spine has a much greater effect than the same amount of elongation downwards, both in diminishing the facial angle and in increasing the distance from the ear to the nasal spine.

A B C D represents the base, E the post-auricular depression, and F the nasal spine; E' represents the position of the postforaminal depression when the ear is more elevated above the foramen magnum A B, or with a more level base A' B' C D. The lines drawn to F' and F'' show the effects of removal of the nasal spine downwards or forwards. The diagram suffices for the geometrical proof of the statements which have been made.

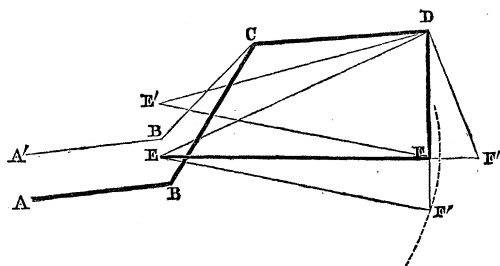

### III. POSITION OF THE SKULL ON THE VERTEBRAL COLUMN.

We are now in a better position to consider the way in which the skull is set on the vertebral column than we were at the commencement of the investigation, as various points which have emerged with regard to form bear on the question of position. This question is the more difficult as it cannot be altogether settled by means of precise methods, as the position of the body is continually changing. It may, however, be pretty safely assumed that in the erect posture the head in the human subject is nearly balanced. There can be no doubt, and it is well known, that in the ordinary standing positions the whole body is supported by balance, while muscular action is only required to preserve that balance. This is seen most distinctly with regard to the lower limbs, for the gastrocnemius and soleus are flaccid in standing, as may be easily proved by observing how they become rigid and change their form as soon as an attempt is made to rise on tiptoe; the flaccidity of the quadriceps extensor cruris is proved by the moveability of the patella so long as the knee is straight and the foot on the ground; and that the glutei muscles are entirely relaxed in standing is shown by observing how the gluteus maximus at once becomes rigid on bending the body forwards, and the gluteus medius and minimus when the opposite foot is lifted up. It is not so easy to prove the relaxation of the muscles of the back in standing, although the curves of the vertebral column speak distinctly enough of balance; but if, with the head held erect and loosely, the fingers of both hands be rested on the upper part of the complexus muscles, and flexion be made from the hips, without changing the relative positions of head, neck, and trunk one to another, those muscles will be felt to swell out and harden, again to relax on resumption of the erect posture. It appears to be a general principle of animal statics that the body can be supported without muscular action; and in the human subject the absence of an elastic ligamentum nuchæ shows that it is not by the principle of suspension that the head is preserved erect.

But if the head be balanced on the vertebral column, it must change its position with growth, and be gradually tilted up more and more from childhood to adult life, to throw more weight behind the condyles as the frontal and temporo-sphenoidal lobes of the brain increase in size, and the face-bones become heavier; and the greater the growth of these parts the greater must be the tilting up. This tilting or rotation back-



wards must be accomplished either by movement of the vertebral column so as to make the upper surface of the atlas look more and more backwards, or by gradually increasing prominence of the anterior extremities of the occipital condyles. There seems to be no evidence that the change is in the position of the atlas; on the contrary, the arch of that vertebra appears to preserve a horizontal position throughout life; but the increasing prominence of the anterior extremities of the condyles is sufficiently great to catch the eye, and is what will now be more explicitly proved.

A flat surface laid on the occipital condyles, and on the skull behind the foramen magnum, having been assumed as horizontal, the degree of elevation of the condyles is easily estimated by measuring the angle which the long axis of the foramen magnum forms with that plane. But the tilting up of the skull is complicated by the increase in cranial curvature which proceeds with growth. Were there no alteration of position of the back part of the skull in the progress from infancy to adult life, the increase in cranial curvature would turn the face more and more downwards; it may be necessary therefore to distinguish tilting up which involves only the back part of the skull from such as involves the whole cranium. With a view to this distinction, as fair an index of the position of the face as can be found is the line of orbital length, and therefore not only the angle at which the horizontal line lies to the long axis of the foramen magnum has been measured (column 77), but also the angle at which it lies to the line of orbital length (column 78).

In infants' skulls the foramen magnum forms the smallest angle with the horizontal line, while the cranial curve being as yet imperfect, the line of orbital length forms a larger angle with the horizontal than it does in many adults. But it is to be recollected that in infants there is at first little attempt at balance, the erect posture being not yet assumed. In the children's skulls the average angle of the foramen magnum with the horizontal remains smaller than that of any of the adults except the Hindoos, while the angle of the line of orbital length has sunk lower than the average of adult males in any nation.

Among adults there seems to be least tilting round in the Hindoos, and next to them in the Australians. In the Esquimaux and Kafirs the angle of the foramen magnum with the horizontal line is not very great; but owing to the small cranial curvature, that of the line of orbital depth is greater than in any of the other nations. In the Irish, French, and Scotch, on the other hand, the angle of the foramen magnum with the horizontal is high, the curvature being great. In the Germans, where the curvature is greatest, the tilting up of the foramen magnum is not quite so great; but this may be accounted for by lightness of the face-bones and by the greatness of the parietal breadth as compared with the frontal breadth in some of them, a circumstance which throws more weight behind the condyles.

It appears very distinctly from the accompanying Table that the female skull is much less tilted back on the condyles than the male, being in this, as in various other respects, more child-like than the male skull; and in the two apparent exceptions to this rule, the Kanaka and Kafir, a full explanation is found in the high cranial curvature.

Deviation from the assumed horizontal plane					
Of the foramen magnum.			Of the line of orbital length.		
4 Infants .....	6·2		11·5		
7 Children .....	7·8		5·5		
	Males.	Females.		Males.	Females.
Hindoo .....	7·6		German .....	5·8	4
Esquimaux .....	8·5		Hindoo .....	7	
Australian .....	9		Australian .....	10	
Kafir .....	10	20	Irish .....	10·8	4·3
Greek .....	10·7		Scotch .....	11·4	8
German .....	13	8·6	French .....	12·8	3·6
Negro .....	13·4	8·5	Greek .....	13·5	
Scotch .....	13·6	11	Negro .....	16·4	9·5
French .....	14·6	11·3	Esquimaux .....	17·5	
Irish .....	15·5	11·6	Kanaka .....	19	8
Kanaka .....	16	17	Kafir .....	20·3	14

After the greatest adult male rotation backwards of the skull has been accomplished, a reverse change may take place as a feature of old-age degeneration. The condyles in that case become flatter, and the head, in consequence of this, is necessarily rotated forwards; for it may be safely assumed that no elevation of the floor of the facets of the atlas takes place, by which alone such rotation could be prevented. That such an old-age degeneration actually occurs can scarcely be denied, but among the skulls measured there are only three well-marked examples of it, namely, the old Scotch skull 40, the German 28, and the Greek 47; they are, however, really good examples. The first two exhibit in a marked manner all the gravitation changes of form; the third does not exhibit those changes in a typical manner, as it has a nearly vertical forehead which can scarcely be imagined to have fallen much backwards; but probably it has undergone a partial change like the German 29, which appears to have enlarged its foramino-basilar angle by the weighing down of the back part of the cranium and its contents. The tendency of the gravitation changes is to throw more of the weight of the brain and skull behind the condyles; and this, together with absorption of the substance of the jaws, and that enlargement of the air-sinuses at the expense of osseous tissue which goes on in old age even after the entrances into the sinuses are blocked up, makes the fore part of the head lighter; and thus the rotation forwards by flattening of the condyles tends to preserve the balance. This flattening of the condyles is in harmony with the general tendency in old age to absorption of osseous matter, especially cancellated tissue—a tendency which is shown in the skull, not only in the extension of the air-sinuses, but in thinning of the bone opposite the inferior occipital fossæ, and in the squamous portions of the temporals. Indeed the much remarked thickening of the skull in old age seems to be confined to those parts which are subjected to increased exposure by baldness.

*Applications of the foregoing remarks to artistic anatomy.*—The foregoing remarks tend to explain the superficial appearances seen in the form of the head at different ages and in the two sexes, as well as in individuals; but, in applying them, it must be

kept in view that the rotations of the skull on the column at different ages involve change in the relations of the flexible soft parts to the bony framework of the features. Hence, while there is no ambiguity as to what is meant by placing the face of either a living or dead person so as to look directly forwards, the greatest of all difficulties in examining skulls is to know how the features lay to the face-bones.

When a young infant is supported with its face directed straight forwards, the most characteristic point in the appearance of its head is the height of the parietal region, which we now know depends partly on the small proportional development of the frontal region, and partly on the position of the skull on the vertebral column; while the prominence of the face in the region of the nostrils depends on the large orbito-nasal angle and the slope upwards and forwards of the line of orbital length, the result of incomplete cranial curvature.

In childhood the parietal height becomes less marked as the forehead fills up; and there being as yet little rotation on the vertebral column, and the orbits remaining comparatively shallow, while the cranial curvature has increased, the frontal eminences appear more prominent than in either the infant or the adult. Thus the frontal region, although it has by no means gained the proportion to the parietal which it bears in the adult, makes a great show; but its actual smallness is revealed by the low position and closeness one to the other of the frontal eminences. Both in infancy and childhood, the midoccipital point, owing to the head being not yet tilted up, is placed very high, which, with the non-development of the tuberosity and the want of muscularity of the neck, gives a slender appearance to the lower and back part of the head.

In the adult male the rotation backwards on the vertebral column combines with the development of the frontal sinuses and face to give a retreating appearance to the forehead, and, together with the increased prominence of the occipital tuberosity, gives a rounded fulness to the lower back part of the skull. It is a grave mistake to predicate deficient development of the anterior lobes of the brain from a retreating forehead, or great development from a vertical forehead, without reference to the rest of the form of the head. Large anterior cerebral lobes may be the cause of a retreating forehead, by causing rotation backwards, for they will add to the weight of the fore part of the head as much as heavy jaws would: but if the cranial curvature be not deficient, the rotation consequent on the weight in front will give a rounded appearance to the lower back part of the skull, by lowering the position of the occipital tuberosity. The physiognomical effect of this is very important. Much is said of the physiognomic value of a high forehead, and little store is placed on fulness of the lower and back part of the head; but the artistic value of apparent occipital development is easily demonstrated by drawing a profile and varying the limiting line of the lower part of the skull behind. The change of one line at this part may be made to convert an intelligent-looking head into that of a weak-minded person, without alteration of a single feature of the face. The anatomical fact which the change of line indicates is an arrest of development of the whole brain, whether large or small, leaving the cranial curvature incomplete.

The question of the beauty of a high or low forehead in the representation of feminine form receives elucidation from the principles laid down. The question is less one of taste than one of anatomy, for the just proportions of the head in the two sexes are as subject to law as those of the trunk. The child-like position of the feminine skull on the vertebral column, dependent on the lightness of the face, and on that deficient frontal capacity demonstrated by HUSCHKE, combines with smallness of the postforaminal angle to cause the continuance of other peculiarities of the young head, viz. an appearance of slenderness at the lower back part, and a rise of the roof as it passes back from the forehead. The kind of height of head required in the representation of feminine beauty is this rise of the roof, a result not of real height but of the position of the head on the vertebral column; the kind of height which is objectionable is height of the frontal eminences. There is probably no objection to the whole arch of the skull being represented high in the female; but it is inconsistent with the greatest feminine grace to place the frontal eminences as high up and as far asunder as they are in the male, and to make the arch retreat horizontally backwards. It is established by WELCKER, WEISBACH, and ECKER\* that the average height of the female cranium is less than that of the male; and although the present measurements do not prove this statement, it is in all likelihood correct. Among the present measurements are several feminine skulls of markedly depressed form, such as do not occur in the male, and others which are not in the least depressed. Probably it may be correct to say that in consequence of the persistence in the female, as has been pointed out by ECKER, of the flatness of the roof found in childhood, the latest accession of height in the male skull is wanting in the female (p. 148), but that the mould of the female head in childhood may vary like the male.

Further characteristics of a femininely shaped head have their origin in peculiarities pointed out in considering the angles in connexion with the arch, viz. the largeness of the orbito-frontal and fronto-parietal angles and the angle of the tuberosity, and the smallness of the frontal, parietal, and postforaminal angles. Among these characteristics those which affect the forehead and roof have been appreciated by ECKER. The difference in the general contour of the profile in male and female may be expressed by drawing a line to represent the male profile round a line representing the female, and making it touch the female profile at the midfrontal point, and in the region extending from the midparietal to the midoccipital point (see Plate XXI.).

#### IV. ANOMALOUS FORMS OF SKULL.

*Unusual magnitude, Kephalon of VIRCHOW.*—The large skull 92, in the possession of Professor THOMSON, appears to be a fair specimen of individual enlargement with preservation of shapeliness, and uncomplicated with hydrocephalus or any other pathological condition; and the peculiarities about to be mentioned are probably most of them common to the majority of cases of individual regular enlargement. The base-line has

\* ECKER, Anthropological Review, October 1868, p. 350, translated from the Archiv für Anthropologie.

undergone no increase; but the elongation of the inferior part of the skull is due to the length of the occipital bone from the foramen magnum to the tuberosity. Hence the proportion of the arch to the base-line exceeds even what is usually found in infancy or childhood, being 3·3. The orbito-frontal angle is large and the midfrontal small, the postforaminal angle large, and the angle of the tuberosity small, so that the combination is produced, not otherwise occurring, of a vertical forehead with prominent eminences going together with the rounded and full appearance given behind by a low-placed tuberosity.

It may further be observed that the enlargement of the arch has taken place principally in the frontal and occipital regions, the parietal remaining of a normal length. Now in the growth from infancy, the frontal and occipital regions normally increase in length as compared with the parietal. If, then, further researches should show that in unusually large skulls the parietal is generally less enlarged than the frontal and occipital regions, we shall have evidence that the excessive development of the arch takes place by a continuance of the method of growth by which the latest steps of its ordinary growth are effected.

The Greek skull 46, already alluded to as having some peculiarities, appears to be an instance of Kephalon less marked and of a different kind. It is true that this skull is not singular in its size, when compared with all the other skulls in the list; it is, however, the largest of the five Greek skulls, and bears evidence of its shape being altered from the national model by continued enlargement. The profile diagram has a much more dolichocephalous appearance than those of the other Greek skulls, and one might be disposed to doubt the alleged nationality; but such a doubt does not explain the peculiarities, namely, the small cranial curvature, the long base-line, and the large orbito-frontal angle. All the peculiarities, however, are removed and the shape of the cranium assimilated to that of the other Greek skulls if we suppose the frontal portion of the arch to be rotated downwards round the fronto-parietal point, so as to lessen the fronto-parietal angle, shorten the base-line, push back the line of orbital length, and throw the foramino-optic line into a more nearly vertical position. This seems to show that this skull presents an instance of individual enlargement accomplished by flattening out of the fronto-parietal angle, the result of elongation of the base-line in consequence of continued levelness of base, the growing brain having pressed too much downwards to admit of the usual contraction of the orbito-basilar angle in process of growth. The enlargement of the skull in this instance is produced less by any unusual increase of size of the bones than by their being placed at unusual angles one to another.

*Hunchback* (skull 93).—This skull exhibits arrest of development in various respects, while in others it is fully grown. There is no deficiency in the face nor in the regions of the base; but the frontal part of the arch is short, and, consequent on this, the deep frontal angle is small and the cranial curvature deficient. Also the midparietal angle is more acute than is usual in adults. These peculiarities, so far as one may judge from external appearances, seem to be very usual among rachitic dwarfs, and not the mere idiosyncrasies of this one skull.

*Cretins and Idiots.*—The Cretin form of skull described by VIRCHOW has been already referred to in treating of the relation of the face to the cranium (p. 153). Reverting again to VIRCHOW's figures of the skull of the Cretin aged fifty-three, and of the new-born Cretin's skull, there seems little difficulty, after all that has been said, in determining the nature of the cranial degeneration, and accounting for the appearance of prognathism which led VIRCHOW to expect a projection of the face from underneath the cranium. The line of attachment of the tentorium, instead of beginning at a considerably lower level than the floor of the anterior fossa of the skull, and passing directly backwards, begins on a level with that part, and appears to rise as it passes backwards; so that, instead of there being increased curvature to make up for shortness of base, as VIRCHOW supposed, there seems to be a marked deficiency in cerebral curvature, and, as it were, a thick slice taken off the lower part of the middle and posterior lobes. This deficiency of curvature does not show itself in the skull by decrease of the angle between the plane of the foramen magnum and the floor of the anterior cranial fossa; but although that angle is the index which we have been using as the measure of curvature, it in this instance misleads in consequence of a drawing up of the front of the foramen magnum, which is not the result of curvature, but of the mere shortness of the basilar process from synostosis, and the crushing up of the dorsum sellæ to the level of the anterior cranial fossa. The want of development backwards of the cerebral hemispheres, indicated by the line of attachment of the tentorium in VIRCHOW's drawings, must, according to the principle of balance, have led to a great tilting backwards of the skull during life, and consequent projection of the jaws. The crushing up of the dorsum sellæ, in these Cretins, to the level of the anterior cranial fossa, is a phenomenon not unlike what has occurred in skull 91 (Professor THOMSON's "baker's skull"), only that in that instance the basilar process has become more horizontal as it has been pushed up, while in the Cretin skulls it has not been so; but in the Cretins, as well as in the "baker's skull," there is the appearance of deformity by gravitation. Probably, as happens in the bones of rachitic skeletons, they had first yielded too freely, and then ossified too rapidly; nor is the circumstance that one of the skulls is that of a new-born infant adverse to this theory, seeing that *in utero* the whole body presses down on the head.

In the skull of the Idiot, 94, there is a totally different state of matters, probably a typical idiot form. Evidently the idiot's skull figured by CARUS\* is of the same description, although still more degenerated. Here there is no defect in the development of the base, no evidence of gravitation changes. The foramino-optic line and orbital length are both long, the base is steep, the cranial curvature great, the face largely developed, and, in connexion with this, there is a frontal sinus projecting far forwards in front of the brain. The base and face have gone through all the stages of a complete and full development; the vault alone is diminished, and that diminution is in height as well as breadth. The deficiency of height is best illustrated by the shortness of the frontal depth; the deficiency of breadth is such that, as already mentioned, the greatest width

\* C. G. CARUS, Neuer Atlas der Cranioscopie, taf. xix.

is between the mastoid processes. Plainly, in this case, the deficient cerebral development is the cause and not the consequence of the form of the skull.

*Artificial deformities.*—Among the American skulls examined three have been subjected to considerable artificial pressure. Of these, the Peruvian, 79, is the least deformed, and the writer has deemed it not unfair to use it in drawing up tables of national peculiarities. One of the other two (95) has been tightly compressed with bandages, while the other (96) has been flattened by boards not interfering with supplemental lateral projection. A study of these two skulls shows some important points. In the flattened skull the proportion of the arch to the base is smaller than in any other skull examined, which, taken in conjunction with the circumstance that the base is a pretty short one, renders it probable that the growth of the roof-bones has been interfered with; but in the other skull, in which the transverse and longitudinal diameters have been equally compressed, there is no evidence of any obstruction to the growth in length of the roof-bones. It does not appear that any arrest in the growth of the base has taken place in either skull. No doubt the orbits are shallow, but they are not unnaturally so; and if it had happened that the development of the frontal sinuses at the proper period had been prevented by pressure in infancy, a thing in itself unlikely, there would have resulted from this, and indeed from any restraint of the normal growth forwards of the frontal bone, a large orbito-nasal angle consequent on the unrestrained natural growth forwards of the lower part of the jaw; but the orbito-nasal angle does not surpass  $90^\circ$  in either skull. The base in both skulls is very level and deficient in cranial curvature; and both these peculiarities are best marked in the flattened skull, in which also the arch is most deformed. The deformity of the arch longitudinally consists in flattening of the frontal and occipital bones and bending of the parietals, as exhibited by the large midfrontal and midoccipital angles and small midparietal angle. Now this deformity of arch results from the cerebral mass being pressed out from the grasp of the compressing agent, and this grasp presses as much downwards as upwards; and although it meets with more resistance in the downward than the upward direction, the effect of the downward pressure is exhibited in the levelness of the base and the deficient cranial curvature,—the action being, in fact, precisely of the same description as has been already mentioned as occurring in the large Greek skull 46.

It is not, however, to be forgotten that, as has been pointed out by Professor TURNER\*, such skulls as these are not subjected to pressure during the whole period of growth, but owe their deformity to pressure in infancy; and the question remains, how it happens that the deformed shape given to the infantile skull is preserved. Professor TURNER suggests arrest of development from premature synostosis as the explanation, and his own observations, together with those of Dr. DANIEL WILSON, show that in such skulls there is great tendency to obliteration of sutures; while the flattened skull 96 gives an instance of arrest of development of the roof-bones. But it is difficult to see how synostosis, although it may occur, accounts for the phenomena sought to be explained. To

\* Natural-History Review, 1864, p. 106.

the writer the explanation seems rather to be found in the consideration that the process of growth in the frontal and parietal bones and occipital squama consists normally of two parts,—the addition of new bone to the margins, extending the planes in which those margins lie, and the change of shape of each bone, by bending and unbending, from the form of a cone with truncated apex at the centre of ossification to a more uniformly curved but, on the whole, flatter shape. In the artificially compressed skulls the frontal and occipital bones are flattened out, while the parietals are forcibly bent; there is no original tendency of the flattened central parts of the frontal and occipital bones to become elevated, and the natural tendency of the parietals to become flatter is insufficient to undo the enormous bending to which they have been subjected; while, in addition, the directions of the planes of marginal growth are entirely changed.

#### V. COMPARISON OF THE HUMAN SKULL WITH THE SKULLS OF VARIOUS ANIMALS.

On comparing the human skull with that of the Chimpanzee or Orang, the most interesting points noticeable in the latter, in connexion with the facts brought forward in this paper, are the smallness of the cranial curvature, and the length of the base as compared with that of the arch. There is also a complete absence of balance of the head on the vertebral column, which is in harmony with the fact that no Ape is capable of supporting itself by balance on its hind limbs, but requires persistent muscular action to prevent it from falling.

To compare the human cranium properly with crania of animals, the cranial cavity must be regarded as a dilated and curved continuation of the spinal canal. The advance in the form of the cranial cavity of Man, as compared with that of the Chimpanzee, consists in increased dilatation both in height and breadth and in increased curvature, whereby not only is the vault expanded, but the bones of the base are crowded together, the postsphenoid and presphenoid being fused, the ethmoid depressed, and the vomer pushed back in the way more fully described by the writer on a former occasion\*. It is curious to note that while the dilatation of the cavity by height is greater in the Orang than in the Chimpanzee, the curvature is much greatest in the Chimpanzee (Plate XXI.).

It is impossible, however, in examining the curvature in the lower animals, to use any longer the means of estimating it which have served us hitherto; for as we pass to lower forms we find the frontal bone coming further down on the face and the optic foramen varying in direction, so that the line joining the optic foramen and fronto-nasal suture no longer indicates any thing with regard to the cranial cavity. Another difficulty, when it is sought to compare the forms of brains, is that the roofs of the orbits, which form the floor of the anterior lobes of the brain, project to a variable and often considerable extent above the level of the cribriform plate. The writer has therefore, with the view of comparing the curvature of the brain in Man and Animals, availed himself of casts of the interiors of the crania of Dean Swift, an Australian, and a Gorilla, prepared under the direction of Professor WRIGHT of Dublin, together with the casts of the interiors of

\* Philosophical Transactions, 1862, p. 296.



the Tartar and Negritic skulls described by Professor HUXLEY; and has taken as an expression of the cerebral curvature the angle between a line laid along the anterior lobe of the brain in the groove formed by the roof of the orbit, and another extending from the torcular Herophili to the most depending part of the middle lobe. The results are:—

Dean Swift . . . . .	164 <sup>o</sup>
Australian . . . . .	164
Tartar . . . . .	155
Negritic skull . . . . .	156
Gorilla . . . . .	130

In the lower Mammalia the direction of the orbit is so variable that it was found necessary to try still another method of comparison. The following results are obtained from vertical sections by measuring the angle between the middle line of the upper surface of the presphenoid in front of the optic commissure, and a line drawn so as to express as nearly as possible the direction of the tentorium.

German, No. 29 . . . . .	184 <sup>o</sup>	Negro, 63 . . . . .	175 <sup>o</sup>	Cat . . . . .	133 <sup>o</sup>
Scotch Female, 43 . . . . .	182	Kafir, 70 . . . . .	191	Dog . . . . .	150
Greek, 44 . . . . .	186	Australian, 73 . . . . .	193	Pig . . . . .	150
Irish Male, 53 . . . . .	196	Synostotic, 89 . . . . .	175	Deer . . . . .	131
„ „ 54 . . . . .	182	Chimpanzee . . . . .	172	Rabbit . . . . .	116
„ Female, 55 . . . . .	177	Orang . . . . .	168	Squirrel . . . . .	99
„ „ 56 . . . . .	182			Turkey . . . . .	103

It is noticeable that this angle varies much in different human skulls, and not according to the variation of the angle of cranial curvature made use of in the former part of this paper. This is probably due partly to the impossibility of estimating the angle with perfect precision, partly to different arrangement of the cerebellum in different skulls, and partly to a circumstance seen best in the Australian, Kafir, and Negro. In those skulls, while the upper surface of the presphenoid is directed to a marked degree downwards as well as forwards, the cribriform plate of the ethmoid is directed again upwards and forwards, so that a mean between the directions of the two parts would most justly express the direction of the floor of the anterior cranial fossa in the middle line. The angle under consideration scarcely exceeds in some human brains the size found in the Chimpanzee and Orang, but in these animals the ethmoid is considerably turned up. Taking this into consideration, together with the comparison of the casts of the interior of the cranium in the human subject and the Gorilla, it may be held that the advance in form of the human brain as compared with the brains of the higher Apes consists partly in an increase of cerebral curvature, dependent on depression of the sphenoid and ethmoid, and on descent of the orbital roofs towards the level of the ethmoid, but to a greater degree consists in increased expansion both in height and breadth of the cranial dilatation of the cerebro-spinal canal.

## DESCRIPTION OF THE SKULLS MENTIONED IN THE GENERAL TABLE.

1 to 6, Fœtal skulls.—1 & 3 are specimens preserved in spirit, the others are dried. The first five were bisected and the section traced with ink on oiled paper; the sixth was measured with the craniometer.

7 to 11, Skulls of new-born infants.—7 was a recent specimen, which was bisected and the section traced. The others are specimens in the Anatomical Museum of the University of Edinburgh.

12 to 18, Children of various ages mentioned in the Table.—The ages of the Edinburgh specimens were taken from the Catalogue and from the dentition of the skulls. 13 is a specimen prepared under the writer's observation.

19 to 27, French.—19 to 24, male; 25 to 27, female. 24 bears the inscription "Soldier of Napoleon and Knight of the Legion of Honour." It is a large and heavy skull, with the face large as well as the cranium, and with the base-line singularly long for a European; probably it belonged to a tall man. 20 has a clino-cephalic depression at the top of the coronal suture, which may have been the result of speno-parietal synostosis; the speno-parietal and speno-frontal sutures are obliterated, and the sagittal begun to disappear. The arch is much thrown backwards. 25 is a marked instance of retention in the adult female of certain infantile characters—levelness of base, unelevated condyles leaving the skull unrotated on the vertebral column, and, in harmony with this, smallness of face and anterior lobes of the brain; the malar and frontal breadth both being very small as compared with the greatest breadth. 26 contrasts with 25 in being high in the arch and steep in the base; both skulls may have exhibited, during life, prominence of forehead, 25 from non-rotation on the column, 26 from shortness of orbital length. 27, the skull apparently of a female about thirty, has undergone a certain amount of deformation in the upper and back part from accidental pressure. The occipital squama is flat, the parietals are curved, and a hollow is formed at the top of the coronal suture, not by restriction of growth from synostosis, but by the rise of the parietals.

28 to 35, German.—Unfortunately there is no information from what part of Germany any of these skulls were obtained. 28 to 32 are male, 33 to 35 female. 28 & 29 are skulls of aged persons. 28 is toothless, very unsymmetrical, with the foramen magnum much sunk between the mastoid processes, and the base fractured, apparently posthumously; the skull is anomalously broad behind. 33 is remarkable for the smallness of the fronto-nasal angle. 34 has the frontal suture open, the base level, the orbit shallow, the face short, and the condyles non-elevated.

36 to 43, Scotch.—36, the skull of the historian GEORGE BUCHANAN. The base is injured, a portion of the occipital bone in front and behind the foramen magnum being destroyed. The injured portion is restored in the diagram in dotted lines, and the possibility of error is extremely slight. This skull was obtained when some alterations were being made in the Grey Friars Church, Edinburgh, and was deposited in the Natural-History Museum of the University. 37, a small skull with a large orbito-nasal

angle, is thus described in Sir GEORGE BALLINGALL'S Catalogue:—"Skull found on the field of Kilsyth, blackened by lying in a moss, and showing several extensive wounds. Supposed to be the head of a Covenanter." 38, skull of a Fife man named EDMUNDS, executed for the murder of his wife, under circumstances, however, of provocation. 39, skull of HAGGART, a noted thief, who was executed. 40 is described in Sir GEORGE BALLINGALL'S Catalogue:—"Skull showing extensive ulceration of the frontal bone, from a gunshot wound received at Waterloo, which the patient survived for many years. Some parts both of the frontal and the parietal bones are thickened to more than half an inch. Both tables of the skull had been involved in the ulcerative process, and an irregular opening is left of nearly 6 inches in circumference, the margins of which have been rounded off. The nasal portions of the frontal bone, as well as the nasal bones and nasal processes of the superior maxillary bones, present a curious appearance. The ethmoid, lachrymal, and other small bones are quite destroyed. As most of the teeth of the upper and the whole of those of the lower jaw are wanting, and the alveolar processes absorbed, it is seen that the subject of this extensive injury, a field-officer in the army, must have lived to an advanced age." 41 is a skull of a young man aged twenty. 42 was not a Museum specimen, and may not have been preserved; it appeared to be the skull of a middle-aged female, and was remarkable in this, that the sphenoidal wings did not reach up to the parietal bones. 43 is the skull of a female aged eighteen. Both 41 and 43 were prepared under the writer's observation.

44 to 48, Modern Greek.—44 and 45 are both marked "from Corfu." 45 is injured at the back of the foramen magnum; it is very unsymmetrical, and remarkable for the length of the foramino-optic line. The slope of the forehead may be fairly attributed to gravitation change. 46, 47, & 48 were preserved to show varieties of sabre cuts, and are described in Sir GEORGE BALLINGALL'S Catalogue as "the skulls of patriot Greeks who fell in the actions between the Turkish and Greek forces, under General CHURCH, in 1827. They were brought from the plain between the Piræus and city of Athens, and presented by Dr. M<sup>c</sup>WILLIAM, R.N." 46 is referred to in the text as an instance in which enlargement of the brain probably prevented the base from increasing in steepness, and thus elongated the base-line, throwing forwards the frontal bone. The position of parts which might have existed if this supposed action had not taken place is illustrated on the diagram by means of dotted lines; it is the skull of a young man. 47 appears to be the skull of an old person, and has a considerable articular surface at the back of the foramen magnum for the arch of the atlas.

49 to 57, Irish.—49 is the skull of a man named HURLEY, from the neighbourhood of Galway, executed for a brutal murder. 50 is the skull of a young man named LYDON, from the neighbourhood of Galway, executed for the murder of his wife who had been unfaithful. 51 is the skull of a tall old man from Ballinasloe. The remaining six Irish skulls are all from the Abbey of Claregalway, where, as in some other neighbouring places, a peculiar custom with respect to burials prevails. There is no sexton; but when a peasant dies, the friends dig a grave within or around the old ruins, displacing the

bones met with, which they think have been long enough in possession of the soil. The exhumed bones are collected in great heaps, some consisting entirely of skulls, others of limb-bones. There is no reason to believe that any of these skulls have much antiquity. Though 52 has been selected as exhibiting most distinctly some of the signs of gravitation, 54 is also apparently the skull of an old person; it is toothless, the sutures begun to be obliterated, and the condyloid surfaces small and flat. 53 has markedly prognathous incisor sockets. 55, 56, & 57 are obviously female skulls. 55 is toothless, and has the condyloid surfaces small and flat. It has no contact of the sphenoid with the parietal on the left side. 57, in the possession of Dr. BRERETON, of Oughterard, has no sphenoparietal suture on either side, but on each side a temporo-frontal suture about  $\frac{3}{4}$  inch long.

58, 59, 60, Hindoo.—60, much more massive than the other two, is marked “Brought from the banks of the Hoogley by the Marquis of Hastings.” All three skulls, together with others in the Anatomical Museum of the Edinburgh University, present unsymmetrical flattening of the occipital region, such as is described by Dr. BARNARD DAVIS as occurring in Siamese skulls\*. Seeking an explanation of the same sort as Dr. DAVIS sought, the writer once asked the wife of an Indian officer if the natives had any peculiar way of cradling their children, and got for answer that they had not, but that they were very fond of laying them on their backs, and that when the Indian nurses placed the English children in that position their mothers turned them on the side, as they fancied lying on the back would make their heads the same round shape as those of the natives. Possibly when the occipital arch is flat, and therefore of a weak form, it more readily yields to accidental pressure than in other cases.

61 to 67, Negro.—61 is the skull of a Negro drummer of a French regiment; the whole skeleton is preserved. 62, the skull of an old person, has a superficial resemblance to an Australian skull, but the arch lacks the characteristic curve of the roof, and the supraorbital ridge is owing to enormous frontal sinuses. 63 has the dorsum sellæ reaching above the level of the floor of the anterior cranial fossa, a sign of a badly developed skull. 64 has the upper part of the occipital bone replaced by a large Wormian bone: this skull and 65 are well developed. 66 is catalogued as a Negress, and has some feminine characters. 67 is marked “Negress, aged fifteen, from West Africa.”

68 to 71, Kafir.—68 has the cranial curvature remarkably deficient, and the posterior nares remarkably low. 71 is female, and, as compared with the males, has a level base and high cranial curvature.

72 & 73, Australian.—73 has the dorsum sellæ on a level with the floor of the anterior cranial fossa.

74 & 75, Kanaka.—74, male; 75, female.

76 & 77, Esquimaux.—76 is of unascertained sex; it presents various feminine characters. 77 is remarkable for its great length of base-line and deficient cranial curvature.

\* *Thesaurus Craniorum*, p. 176.

78 & 79, Peruvian.—78, skull of supposed Inca, from Temple of the Sun. The roof is partially covered with fine brown hair, 3 or 4 inches long. The only evidences of compression are a slight depression and want of symmetry above the occipital tuberosity and a slight flatness in the midfrontal region, which might be the accidental result of wearing some kind of head-dress. 79, also a supposed Inca, “dug up near Arica, in a burial-ground which had been disused since the conquest by Pizarro in 1532, by R. T. C. SCOTT, Surgeon, H.M.S. Talbot.” The results of compression by bandages are very obvious.

80, skull of BURKE the murderer.—The peculiarities of this singular skull are probably chiefly referable to gravitation changes prematurely setting in, either from softness of the bones or carrying weights on the head.

81, “skull of PEPE, a Spaniard, captain of a piratical crew, who was captured at the Isle of Pines, by Captain GRAHAM, R.N.”—From accounts of this man, which do not seem to have passed through many hands, he appears to have been a monster of brutality. The skull is also a singular one. The foramino-optic line is extremely long, and the cranial curvature deficient, while the posterior half of the skull appears to be too slender from above downwards for the fore part. The condyles are unusually prominent; and by this circumstance, together with the deficient cranial curvature, the head is thrown in the diagram into a position which it could scarcely have occupied in life.

82, Swiss.—This is probably a female skull.

83, Turk.

84, Tartar.

85, Chinese.—The skull of a young man.

86, Maori.—For the opportunity of examining this skull, in the possession of Dr. MURRAY, who brought it from New Zealand, I am indebted to the kindness of Dr. HENRY S. WILSON.

87, Hottentot Chief.—This is an uncommonly large skull with a very large orbito-nasal angle.

88, Carib.—This skull is remarkable for its flat retreating forehead, great orbital length, and long base-line. The orbito-nasal angle is rather small.

89, French acrocephalus.—The deformity is the result apparently of synostosis of the lower parts of the coronal suture, whereby the growth of the orbital length has been checked, while the loss of growth forwards has been supplemented by exaggerated height at the vertex. The dorsum sellæ reaches above the level of the anterior cranial fossa; and the levelness of base indicates that the brain has exercised pressure downwards as well as upwards.

90, a low and elongated skull illustrating aberrant form not caused by synostosis.—It is toothless, the frontal suture open, as also the others, save that the lower parts of the coronal and the fronto-sphenoidal sutures are beginning to fade.

91, skull with the base curiously driven in, as if by carrying great weights, such as a baker's tray.

- 92, anomalously large skull.
- 93, skull of a hunchback ; dissecting-room specimen.
- 94, skull of an idiot, who died in Morningside Asylum.
- 95, compressed Chinook skull from Columbia River.
- 96, flattened Carib or other skull, allowed to grow unlimitedly in breadth.

#### EXPLANATION OF PLATES XII.-XXI.

Fifty-seven of the ninety-six skulls whose measurements are given in the General Table are represented in the Plates, and are there distinguished by the same numbers as in the Table ; the letter *f* being added in the case of female skulls. The first five, namely, four foetal skulls and the skull of an infant at birth, are represented full size ; all the rest are reduced to half-size. The cranial area in each case is divided by lines into frontal, parietal, upper occipital, and lower occipital parts ; and the number of degrees in a few of the more important angles is expressed in figures to assist the eye in comparing different forms. Also the positions of the upper and lower borders of the orbit are in most cases expressed by a line uniting those two points ; the position of the upper extremity of the temporo-malar suture is indicated by the lower end of a short curved line, above which the maximum breadth between the zygomatic arches is stated ; and a straight line is drawn from the point where the greatest depth of the cranium occurs to the position of the greatest breadth in the course of the coronal suture, termed the frontal breadth, the amount of breadth at these two points being indicated at the extremities of the line.

To give the diagrams framed from measurements greater completeness, the curve of the arch was obtained by means of a lead wire pressed against the skull, and then carefully laid on the diagram ; and the curves so obtained are reproduced in the Plates. This method, together with other useful hints, was recommended to the writer by Dr. HECTOR, now of New Zealand ; and it is right to state that the recommendation was given previous to the appearance of HUSCHKE'S work, in which the same method is described. Used with care the lead wire gives details of the arch curves not easily otherwise obtained. Those instances, however, in which tracings of vertical sections have been secured show that the points settled by measurement are more accurate than the indications of the lead wire.

In Plate XXI. the figure of skull 91 has been obtained entirely by means of measured points and the lead wire, without the assistance of a vertical section. The views of the skulls of animals in this Plate are taken from tracings of vertical sections, and the names of the animals are mentioned in the Plate.

List of Skulls measured.  (E. stands for Anatomical Museum, University of Edinburgh; E.N. for Natural-History Museum of that University; T. for Professor Thomson's Collection; and Q.C.G. for Queen's College, Galway.)	The arch and its portions.										Chords of pc	
	From foramen magnum to occipital tuberosity.	From occipital tuberosity to upper angle of occipital bone.	Occipital arc from foramen magnum upwards.	Parietal arc along the sagittal suture.	Frontal arc to fronto-nasal suture.	Total arch from foramen magnum to fronto-nasal suture.	Base-line from back of foramen magnum to fronto-nasal suture (chord of total arch).	Proportion of arch to the base reckoned as 1.	Proportion of occipital arc to parietal arc reckoned as 100.	Proportion of frontal arc to parietal arc reckoned as 100.	Occipital chord.	Parietal chord.
	1	2	3	4	5	6	7	8	9	10	11	12
<b>POSTAL SKULLS.</b>												
1. Four months old, wet	.3	.5	.8	1.4	1.15	3.35	1.45	2.31	57	82	.75	1.2
2. Five months old, dry, Q.C.G.	.6	1.	1.6	2.3	2.1	6.	2.	3.	70	91	1.4	2.
3. Five months old, wet	.6	1.1	1.7	2.4	2.	6.1	2.4	2.54	70	83	1.5	2.15
4. Seven months old, dry, Q.C.G.	.8	1.6	2.4	2.8	2.5	7.7	2.6	2.96	85	89	1.9	2.5
5. Eight months old, dry, E.	1.	1.3	2.3	3.1	2.5	7.9	2.6	3.03	74	80	2.05	2.6
6. Eight months old, dry, Q.C.G.	1.	1.3	2.3	3.2	2.6	8.1	2.9	2.8	71	81	2.05	2.7
Average	.....	.....	.....	.....	.....	.....	.....	2.77	74	84	.....	.....
<b>AT BIRTH.</b>												
7. Recent section	1.1	1.8	2.9	3.5	2.4	8.8	2.9	3.03	82	68	2.6	2.9
8. E. (Monro's) 1	1.2	1.8	3.	3.5	2.7	9.2	3.	3.06	85	77	2.5	2.95
9. E. (Monro's) 2	1.3	1.6	2.9	3.5	2.7	9.1	2.9	3.14	82	77	2.45	2.95
10. E. 498	1.1	1.55	2.65	3.45	2.7	8.8	2.8	3.14	76	78	2.35	3.
11. E. 123 c	1.2	1.4	2.6	3.2	3.	8.8	3.	2.93	81	93	2.25	2.8
Average	.....	.....	.....	.....	.....	8.94	2.92	3.06	81	78	.....	.....
<b>AFTER BIRTH.</b>												
12. 1 year old, E. 123 b	1.6	2.	3.6	4.4	3.4	11.4	3.6	3.16	81	77	2.95	3.75
13. 2½ years, girl, T.	1.6	2.2	3.8	4.5	3.9	12.2	4.1	2.97	84	86	3.4	3.85
14. 3 years, E. 133 a	2.1	2.1	4.2	4.5	4.1	12.8	4.4	2.90	93	91	3.5	3.95
15. 3 years, E. 122 b	1.6	2.3	3.9	5.4	4.6	13.9	4.4	3.15	72	85	3.35	4.7
16. 5 years, E. 133	2.	2.8	4.8	4.8	5.	14.6	4.3	3.39	100	104	3.8	4.25
17. 6 years, E. 115	1.8	2.6	4.4	5.4	5.	14.8	4.7	3.15	81	92	3.7	4.9
18. 10 years, boy, E. 6	2.4	2.4	4.8	5.4	5.2	15.4	5.1	3.02	88	96	3.95	4.7
Average	.....	.....	.....	.....	.....	.....	.....	3.07	85	90	.....	.....
<b>FRENCH.</b>												
19. Male, E. No. 21	1.9	2.6	4.5	4.5	4.8	13.8	5.3	2.60	100	106	3.7	4.
20. " E. No. 24	1.3	3.1	4.4	4.5	4.7	13.6	5.5	2.47	97	104	3.7	4.2
21. " E. No. 25	2.2	2.2	4.4	5.	4.9	14.3	5.1	2.80	88	98	3.6	4.5
22. " E. No. 26	1.6	2.6	4.2	4.9	4.6	13.7	5.6	2.44	85	93	3.5	4.3
23. " E. No. 28	1.7	2.6	4.3	4.6	4.9	13.8	5.	2.76	93	106	3.7	4.3
24. " E. Old Soldier	1.8	3.4	5.2	4.4	5.2	14.8	5.7	2.59	118	118	3.9	4.
25. Female, E. No. 27	1.6	2.7	4.3	4.7	4.8	13.8	5.1	2.70	91	102	3.6	4.2
26. " E. No. 29	1.8	2.5	4.3	5.05	4.95	14.3	4.9	2.91	85	98	3.6	4.5
27. " E. No. 23	1.9	2.5	4.4	4.7	4.7	13.8	5.	2.76	93	100	3.8	4.
Average	.....	.....	.....	.....	.....	13.98	5.24	2.67	94	102	.....	.....
<b>GERMAN.</b>												
28. Male, E. No. 37	1.8	2.8	4.6	4.5	5.7	14.8	5.1	2.90	102	126	3.7	4.1
29. " E. No. 37 a	1.8	3.2	5.	5.	5.3	15.3	5.3	2.88	100	106	3.8	4.7
30. " E. No. 41	2.	2.7	4.7	4.7	5.1	14.5	5.3	2.73	100	108	3.7	4.3
31. " E. No. 42	1.7	2.8	4.5	5.	5.2	14.7	5.3	2.77	90	104	3.7	4.5
32. " E. No. 43	1.9	2.5	4.4	5.3	5.1	14.8	5.2	2.84	83	96	3.6	4.8
33. Female, E. No. 38	1.9	2.4	4.3	5.	4.9	14.2	5.	2.84	86	98	3.6	4.5
34. " E. No. 39	1.5	3.1	4.6	4.7	4.3	13.6	4.9	2.77	97	91	3.5	4.2
35. " E. No. 40	1.6	2.6	4.2	4.4	4.8	13.4	5.	2.68	95	109	3.4	4.1
Average	.....	.....	.....	.....	.....	14.41	5.13	2.80	94	104	.....	.....
<b>SCOTCH.</b>												
36. George Buchanan, E.	2.?	2.4	4.4?	4.8	4.6	13.8?	5.1?	2.70?	87?	95	3.6?	4.2
37. From Kilsyth, E. (Ballingall's) B. VII.*	1.7	2.6	4.3	4.2	4.6	13.1	5.	2.62	102	109	3.7	3.9
38. Edmunds, E.	1.9	3.1	5.	4.9	4.85	14.75	5.6	2.60	102	99	4.15	4.5
39. Haggart, E.	2.1	2.5	4.6	5.	5.2	14.8	5.2	2.84	92	104	3.9	4.6
40. Old Officer, E. (Ballingall's) B. VI.	2.1	2.75	4.85	5.2	5.5	15.55	5.	3.11	93	105	3.9	4.8
41. Male, set 20, T.	1.7	2.75	4.45	5.15	5.2	14.8	5.4	2.74	86	101	3.9	4.5

# GENERAL TABLE OF MEASUREMENTS.

Chords of portions of the arch.					Angles connected with the arch.									Pons of the base.			Angles connected with the			
Parietal chord.	Frontal chord.	Proportion of occipital chord to parietal chord reckoned as 100.	Proportion of frontal chord to parietal chord reckoned as 100.	Postforaminal angle.	Angle at occipital tuberosity.	Midoceipital angle.	Occipito-parietal angle.	Midparietal angle.	Fronto-parietal angle.	Midfrontal angle.	Orbito-frontal angle.	Orbito-nasal angle.	Length of foramen magnum.	Foramino-optic line from foramen magnum to level of optic foramen.	Orbital depth from foramen opticum to fronto-nasal suture.	Foramino-basilar angle.	Orbito-basilar angle.	Angle of cranial curve.	Foramino-palatinal angle.	
12	13	14	15	16	17	18	19	20	21	22	23	24	25	26	27	28	29	30	31	
5	1-2	62	83	140	150	151	156	125	143	132	99	90	55	55	55	117	147	150	168	
	2-15	70	90	158	145	150	137	136	137	128	100	93	6	75	7	153	167	166	185	
	2-5	76	88	170	141	137	155	125	146	132	97	93	8	9	9	139	143	176	201	
	2-6	78	83	152	147	154	140	121	153	138	89	87	7	1-05	9	140	165	155	184	
	2-7	76	88	153	150	149	148	120	154	137	92	86	1	1-15	1-05	129	152	157	193	
5	.....	72	84	151	146	148	147	126	147	131	95	88	.....	.....	.....	137	155	162	188	
	2-9	90	75	142	148	145	134	125	162	131	88	102	7	1-1	1-1	148	147	181	205	
	2-95	84	77	140	155	135	143	127	160	120	104	94	8	1-1	1-2	148	155	173	198	
	3-	83	81	146	142	142	148	124	152	131	91	103	8	1-1	1-15	143	142	181	206	
	2-8	78	80	156	160	139	135	131	152	133	93	97	7	1-2	1-15	128	140	168	194	
	2-55	80	91	143	143	148	149	129	150	126	92	96	1	1-1	1-1	139	142	177	201	
5	.....	83	80	145	149	141	141	127	155	128	93	98	8	1-12	1-14	141	145	176	200	
	3-75	78	80	159	134	142	152	124	150	134	88	93	1-05	1-35	1-4	134	139	175	198	
	3-85	88	88	140	145	144	145	130	153	128	89	90	1-	1-3	1-65	134	132	182	203	
	3-95	88	91	131	145	140	154	138	151	127	93	88	1-4	1-5	1-7	150	147	183	212	
	4-7	71	84	144	152	139	143	132	140	126	91	86	1-5	1-6	1-6	137	131	186	204	
	4-25	89	97	151	140	137	150	135	150	122	89	86	1-2	1-5	1-7	145	138	187	215	
	4-9	75	86	148	154	134	148	129	147	125	89	87	1-4	1-75	1-85	136	134	182	212	
	4-7	84	95	144	137	147	155	132	148	128	85	89	1-6	1-95	1-8	138	137	181	210	
5	.....	81	88	146	143	140	149	131	148	127	89	88	.....	.....	.....	139	136	182	208	
	4-	92	112	139	127	155	160	134	148	133	79	93	1-25	2-2	2-	152	147	185	214	
	4-2	88	104	158	140	142	146	137	151	136	70	97	1-5	2-45	1-95	134	135	179	202	
	4-5	80	100	147	138	141	164	133	144	135	77	93	1-4	2-2	1-85	137	134	183	213	
	4-3	81	97	141	129	158	155	129	151	138	79	86	1-5	2-2	2-05	150	144	186	216	
	4-3	86	100	152	138	148	145	132	152	131	77	91	1-6	2-	1-75	135	133	182	209	
	4-	97	115	163	124	141	149	144	153	132	77	89	1-4	2-4	2-1	142	146	176	202	
	4-2	85	102	140	141	140	152	133	153	128	84	86	1-4	1-95	1-9	162	153	189	218	
	4-5	80	97	148	137	152	151	131	147	126	81	96	1-5	2-15	1-7	136	128	188	211	
	4-	95	107	140	133	164	150	121	157	128	81	95	1-4	2-	1-9	139	133	186	213	
5	.....	87	103	147	134	148	152	132	150	131	78	91	1-43	2-17	1-9	143	139	183	210	
	4-1	90	120	158	122	158	146	137	146	128	76	94	1-4	2-1	1-9	147	138	189	212	
	4-7	80	100	154	125	145	147	144	141	138	80	87	1-45	2-2	1-9	153	141	192	219	
	4-3	86	102	151	130	144	156	133	153	127	78	89	1-35	2-3	1-95	141	138	183	201	
	4-5	82	100	143	138	147	152	133	149	128	84	92	1-5	2-	2-	149	143	186	211	
	4-8	75	93	145	133	153	153	133	142	128	85	86	1-6	2-05	1-9	142	136	186	217	
	4-5	80	97	151	138	149	152	130	146	134	79	79	1-4	2-	1-9	136	136	180	218	
	4-2	83	90	147	134	132	156	132	155	127	87	89	1-35	1-95	1-7	162	152	190	214	
	4-1	83	102	151	130	148	153	137	147	128	79	94	1-35	2-15	1-8	140	136	184	208	
5	.....	82	100	150	131	147	151	134	147	128	81	88	1-42	2-09	1-88	146	140	186	212	
?	4-2	85?	100	.....	.....	155	151	132	150	137	76	87	1-4	2-1?	2-	.....	.....	180?	207	
	3-9	94	107	149	137	150	149	142	142	137	77	99	1-5	2-1	2-	127	130	177	198	
	4-5	92	97	140	140	141	157	137	145	135	81	87	1-5	2-35	2-1	141	137	184	213	
	4-6	84	101	140	141	144	159	130	147	129	80	94	1-5	2-1	2-	140	132	188	212	
	4-8	81	104	166	120	143	152	139	140	133	74	84	1-55	2-25	1-8	137	133	184	206	
	4-5	86	100	146	149	143	151	127	152	130	80	94	1-5	2-3	2-1	133	135	178	202	
	4-7	85	90	152	133	135	150	136	150	132	82	86	1-5	2-2	1-85	142	139	183	210	



ed with the base.			Distance of various points in the arch from the base.						
Angle of cranial curve.	Foramino-palatatal angle.	Deep frontal angle.	Occipital depth from spheno-occipital suture to occipital tuberosity.	Occipito-parietal depth from spheno-occipital suture to top of occipital.	Parietal depth from spheno-occipital suture to midparietal point.	Frontal depth from optic foramen to fronto-parietal suture.	Proportion of occipital depth to parietal depth reckoned as 100.	Proportion of occipito-parietal depth to parietal depth reckoned as 100.	Proportion of frontal depth to parietal depth reckoned as 100.
30	31	32	33	34	35	36	37	38	39
150	168	75	1	1.35	1.4	1.05	71	96	75
166	185	85	1.5	2.05	2.2	1.75	68	93	79
176	201	81	1.6	2.1	2.1	1.55	76	100	73
155	184	83	1.9	2.7	2.8	2.1	67	96	75
169	199	87	2.05	2.7	2.95	2.05	69	91	69
157	193	85	2.3	3.	3.25	2.25	70	92	69
162	188	82	.....	.....	.....	.....	70	94	73
181	205	85	2.2	3.2	3.15	2.	69	101	63
173	198	78	2.2	3.1	3.5	2.2	67	95	67
181	206	86	2.45	3.1	3.	2.2	74	93	66
168	194	85	2.15	3.	3.5	2.2	68	95	69
177	201	92	2.5	3.	3.	2.3	78	93	71
176	200	85	.....	.....	.....	.....	71	95	67
175	198	88	3.2	3.9	4.	2.7	80	97	67
182	203	87	3.45	4.3	4.4	3.	78	97	68
183	212	86	3.8	4.4	4.5	3.25	84	97	72
186	204	93	3.5	4.6	4.8	3.6	72	95	75
187	215	97	3.8	4.8	4.8	3.6	79	100	75
182	212	93	3.8	4.9	5.5	3.8	73	95	73
181	210	96	4.4	5.15	5.4	3.85	81	95	71
182	208	91	.....	.....	.....	.....	78	96	71
185	214	97	3.9	4.55	5.	3.7	78	91	74
179	202	105	3.65	4.9	4.95	3.4	73	98	68
183	213	101	4.1	4.75	5.1	3.7	80	93	72
186	216	94	3.7	4.4	4.9	3.5	75	89	70
182	209	103	3.6	4.7	4.9	3.5	73	93	70
176	202	101	4.	5.	5.	3.65	80	100	73
189	218	96	3.5	4.5	4.7	3.7	74	95	78
188	211	104	3.8	4.7	5.2	3.6	73	90	69
186	213	.99	3.7	4.7	5.2	3.5	71	90	67
183	210	100	.....	.....	.....	.....	76	93	71
189	212	110	3.8	4.8	5.1	3.9	74	94	76
192	219	102	3.85	4.85	5.	3.85	77	97	77
183	201	102	4.1	4.8	5.	3.5	82	96	70
186	211	95	3.75	4.7	5.1	3.85	73	92	75
186	217	96	4.	4.7	5.2	3.85	76	90	74
180	218	98	3.95	4.8	5.2	3.6	75	92	69
190	214	92	3.5	4.25	4.5	3.25	77	94	72
184	208	102	3.65	4.45	4.8	3.35	76	92	69
186	212	99.6	.....	.....	.....	.....	76	93	72
80?	207?	97	3.95	4.75	5.	3.4	79	95	68
77	198	96	3.8	4.6	4.7	3.5	80	97	74
84	213	93	4.05	4.95	5.3	3.7	76	93	69
88	212	100	4.05	4.9	5.35	3.8	75	91	71
84	206	111	4.4	5.25	5.4	4.1	81	97	75
78	202	98	3.7	4.9	5.1	3.8	68	90	70
83	210	95	4.05	5.05	5.15	3.6	78	93	69

37. From Kusyut, E. (Ballingall's) B. VII.	1-9	3-1	5	5	4-9	4-85	14-75	5-6	2-60	102	99	4-15	4-5
38. Edmunds, E.	2-1	2-5	4-6	5	5-2	5-2	14-8	5-2	2-84	92	104	3-9	4-6
39. Haggart, E.	2-1	2-75	4-85	5-2	5-5	5-5	15-55	5	3-11	93	105	3-9	4-8
40. Old Officer, E. (Ballingall's) B. VI.	1-7	2-75	4-45	5-15	5-2	5-2	14-8	5-4	2-74	86	101	3-9	4-5
41. Male, set. 20, T.	1-9	3-2	5-1	5-2	4-8	5-1	15-1	5-2	2-86	98	92	4	4-7
42. Female, middle aged, E.	1-9	3-2	5-1	5-2	4-8	5-1	14-6	5-4	2-70	90	102	3-9	4-5
43. " set. 18, T.	1-7	2-8	4-5	5	5	5-1	14-6	5-4	2-70	90	102	3-9	4-5
Average	.....	.....	.....	.....	.....	.....	14-52	5-3	2-72	93	100	.....	.....
GREEK.													
44. From Corfu, E. No. 45	1-8	2-2	4	5-1	4-8	4-8	13-9	5	2-78	78	94	3-3	4-5
45. " E. (Monro's)	1-9?	3	4-9?	4-8	5-2	5-2	14-9?	5-3?	2-81?	102?	108	3-9?	4-4
46. E. (Ballingall's) B. III.	1-8	2-8	4-6	5	5	5	14-6	5-6	2-60	92	100	3-85	4-5
47. " B. IV.	1-6	2-5	4-1	5	4-8	4-8	13-9	5-2	2-67	82	96	3-4	4-5
48. E. " B. V.	1-5	2-9	4-4	5	4-6	4-6	14	5-4	2-59	88	92	3-95	4-6
Average	.....	.....	.....	.....	.....	.....	14-2	5-3	2-69	88	98	.....	.....
IRISH.													
49. Male, Hurley, Q.C.G.	1-75	2-95	4-7	5-4	5-6	5-6	15-7	5-5	2-85	87	103	3-8	4-9
50. " Lydon, Q.C.G.	1-7	2-7	4-4	5-1	4-9	4-9	14-4	5	2-88	86	96	3-6	4-5
51. " From Ballinasloe, old, Q.C.G.	2-3	2-4	4-7	5-1	5-5	5-5	15-3	5-3	2-88	92	107	3-8	4-7
52. " From Claregalway, Q.C.G.	2	2-9	4-9	4-9	5	5	14-8	5-4	2-74	100	102	3-8	4-4
53. " " "	1-8	3-7	5-5	5	5	5	15-5	5	3-10	110	100	4-1	4-5
54. " " "	1-9	2-3	4-2	5-9	5-6	5-6	15-7	5-2	3-01	71	94	3-5	5-2
55. Female " "	1-9	2-8	4-7	5	5-2	5-2	14-9	5-2	2-86	94	104	3-8	4-6
56. " " "	1-9	2-5	4-4	4-7	4-9	4-9	14	5-1	2-74	93	104	3-5	4-5
57. " " "	2	2-9	4-9	5	4-9	4-9	14-8	5	2-96	98	98	3-8	4-3
Average	.....	.....	.....	.....	.....	.....	15-01	5-18	2-89	91	100	.....	.....
HINDOO.													
58. E. No. 48	1-9	2-3	4-2	4-8	5-3	5-3	14-3	5-1	2-80	87	110	3-7	4-2
59. E. No. 49	1-6	2-7	4-3	4-9	4-7	4-7	13-9	4-9	2-83	87	97	3-7	4-4
60. E.N.	1-8	2-7	4-5	5-1	4-8	4-8	14-4	5-3	2-71	88	94	3-75	4-6
Average	.....	.....	.....	.....	.....	.....	14-2	5-1	2-78	87	100	.....	.....
NEGRO.													
61. Male, E. No. 3	2	2-1	4-1	5-6	4-9	4-9	14-6	5-5	2-65	73	87	3-5	5-1
62. " E. No. 52	1-7	2-3	4	5	4-7	4-7	13-7	5-6	2-44	80	94	3-4	4-5
63. " E. No. 53	1-8	2-5	4-3	4-9	4-8	4-8	14	5-7	2-45	87	98	3-7	4-65
64. " E. No. 54	1-7	2-6	4-3	4-6	5-1	5-1	14	5-4	2-59	93	110	3-6	4-2
65. " E. No. 55	1-4	3-8	5-2	4-8	5-2	5-2	15-2	5-4	2-81	108	108	4-3	4-3
66. Female, E. No. 56	1-8	2-5	4-3	4-9	5-2	5-2	14-4	5-3	2-71	87	106	3-7	4-5
67. " set. 15, E. (Monro's)	2	2-4	4-4	4-9	4-9	4-9	14-2	5	2-84	90	100	3-7	4-3
Average	.....	.....	.....	.....	.....	.....	14-30	5-41	2-64	88	100	.....	.....
KAFIR.													
68. Male, E. No. 59	1-8	3-2	5	5-3	5-3	5-3	15-6	5-8	2-69	94	100	4-2	4-8
69. " E. (Monro's)	1-9	2-6	4-5	4-9	5-1	5-1	14-5	5-7	2-54	91	104	3-7	4-5
70. " E. (Dr. Black's)	2-1	2-5	4-6	5-4	5-1	5-1	15-1	5-5	2-74	85	94	3-8	4-9
71. Female, E.	1-9	2-5	4-4	4-5	4-6	4-6	13-5	5-3	2-54	97	102	3-8	4-2
Average	.....	.....	.....	.....	.....	.....	14-67	5-57	2-62	91	100	.....	.....
AUSTRALIAN.													
72. E.N.	1-7	2-7	4-4	5-2	4-9	4-9	14-5	5-5	2-63	84	94	3-7	5
73. E. No. 66	1-7	2-55	4-25	5-1	4-9	4-9	14-25	5-4	2-63	83	98	3-5	4-7
Average	.....	.....	.....	.....	.....	.....	14-37	5-45	2-63	83	96	.....	.....
KANAKA.													
74. Male, E.	1-6	2-7	4-3	5-1	5-2	5-2	14-6	5-5	2-65	84	102	3-85	4-6
75. Female, E.	1-9	2-7	4-6	5-4	4-7	4-7	14-7	5	2-94	85	87	3-9	4-85
Average	.....	.....	.....	.....	.....	.....	14-65	5-25	2-79	84	94	.....	.....
ESQUIMAUX.													
76. E. (Monro's)	1-8	2-8	4-6	4-6	5	5	14-2	5-3	2-67	100	108	3-8	4-2
77. E. 68 a	1-3	3	4-3	4-4	4-8	4-8	13-5	5-9	2-28	97	109	3-6	4-1
Average	.....	.....	.....	.....	.....	.....	13-85	5-6	2-47	98	108	.....	.....
PERUVIAN.													
78. E.N.	1-7	2-3	4	4-8	4-3	4-3	13-1	4-8	2-72	83	90	3-5	4-1
79. E.N.	1-8?	2-3	4-1?	4-7	5-2	5-2	14-?	5-1?	2-74?	87?	110	3-8?	4
Average	.....	.....	.....	.....	.....	.....	.....	.....	.....	85	100	.....	.....
MISCELLANEOUS.													
80. Burke, E.	1-9	2-4	4-3	5-2	4-8	4-8	11-3	5-4	2-64	82	92	3-3	4-55
81. Spanish pirate, E. No. 33	1-9	2-4	4-3	5	5	5	14-3	5-5	2-60	86	100	3-8	4-6
82. Swiss, E. No. 34	1-8	2-9	4-7	4-5	5	5	14-2	5-3	2-67	104	111	3-9	4-2
83. Turk, E. (Monro's)	1-6	2-8	4-4	4-7	4-7	4-7	13-8	5-1	2-70	93	100	3-7	4-3
84. Tartar, E. No. 46	1-7	3-1	4-8	4-4	4-8	4-8	14	5-4	2-59	109	109	4-1	4-1
85. Chinese, E.	1-9	2-9	4-8	4-8	4-8	4-8	14-4	4-8	3-00	100	100	3-95	4-3
86. Maori	1-7	2-8	4-5	5-5	5	5	15	5-7	2-63	81	90	3-7	5
87. Hottentot Chief, E.	1-7	3-3	5	5-4	5-5	5-5	15-9	5-8	2-74	92	101	4-2	4-9
88. Carib, E. No. 62	2-1	2-8	4-9	5	4-9	4-9	14-8	5-9	2-50	98	98	4	4-5
89. Spontotic French, E. No. 32	1-4	3	4-4	4-7	4-4	4-4	13-5	5	2-70	93	93	3-7	4-2



84	213	93	4.05	4.95	5.3	3.7	76	93	69
88	212	100	4.05	4.9	5.35	3.8	75	91	71
84	206	111	4.4	5.25	5.4	4.1	81	97	75
78	202	98	3.7	4.9	5.1	3.8	68	90	70
83	210	95	4.05	5.05	5.15	3.6	78	93	69
83	209	100	3.75	5.1	5.4	3.7	69	94	68
82	207	98.8	.....	.....	.....	.....	75	94	70
75	203	93	3.5	4.4	4.9	3.7	71	89	75
88?	205?	104	4.	4.8	5.1	3.7	78	94	72
72	204	86	4.1	5.	5.3	3.8	77	94	71
85	210	91	3.7	4.2	4.8	3.6	77	87	75
72	202	87	3.7	4.95	5.2	3.65	71	95	70
77	204	93.2	.....	.....	.....	.....	74	91	72
78	215	94	4.2	5.3	5.5	4.2	76	96	76
81	212	95	3.8	4.9	5.	3.6	76	98	72
89	217	104	4.5	5.2	5.3	3.7	84	98	69
84	210	97	4.3	4.9	5.	3.6	86	98	72
89	212	92	3.9	5.	5.1	3.8	76	98	74
87	210	98	4.1	5.	5.4	4.	75	92	74
88	217	100	4.1	5.	5.1	3.8	80	98	74
88	220	99	4.2	4.9	4.9	3.4	85	100	69
86	219	105	4.1	5.	5.2	3.4	78	96	65
35	214	98.2	.....	.....	.....	.....	79	97	71
30	212	102	3.7	4.7	5.3	3.9	69	88	73
31	201	94	3.7	4.7	5.1	3.6	72	92	70
31	205	94	3.75	4.7	5.2	3.65	72	90	70
30	206	96.6	.....	.....	.....	.....	71	90	71
78	197	100	4.4	5.15	5.15	3.45	85	100	66
76	201	94	3.85	4.6	5.	3.45	77	92	69
70	200	92	4.2	5.1	5.1	3.6	82	100	70
74	205	94	3.9	4.7	5.1	3.8	76	92	74
57	212	97	3.7	5.2	5.4	3.8	68	96	70
32	204	96	4.	4.8	5.1	3.8	78	94	74
76	198	96	4.1	5.	5.15	3.5	79	97	67
77	202	95.5	.....	.....	.....	.....	77	95	70
35	193	90	4.1	5.5	5.8	4.2	70	93	72
38	197	91	4.3	5.1	5.2	4.1	82	98	78
76	200	94	4.1	5.	5.2	3.8	78	96	73
36	216	92	3.9	4.8	5.1	3.6	76	94	70
73	201	91.7	.....	.....	.....	.....	76	95	73
30	202	93	3.95	4.8	5.1	3.65	77	94	71
32	206	95	3.8	4.7	5.	3.7	76	94	74
31	204	94	.....	.....	.....	.....	.....	94	72
7	195	98	3.75	5.05	5.5	3.75	68	91	68
9	210	94	3.85	5.	5.3	3.5	72	94	66
3	202	96	.....	.....	.....	.....	70	92	67
8	207	97	4.	4.9	5.1	3.7	78	96	72
4	189	95	4.	5.	5.2	3.8	76	96	73
1	198	96	.....	.....	.....	.....	77	96	72
3	208	95	3.4	4.3	4.9	3.4	69	87	69
..	.....	100	3.95	5.2	5.9	3.9	66	88	66
..	.....	97.5	3.67	4.75	5.4	3.65	67	87	67
6	204	99	4.	4.7	4.8	3.4	83	97	70
2	195	103	4.	5.1	5.2	3.5	76	98	67
3	208	98	3.9	5.	4.95	3.7	78	101	74
4	202	97	3.7	4.9	5.	3.4	74	98	68
8	207	97	4.	5.1	5.	3.4	80	102	68
8	209	101	3.95	5.	5.1	3.5	77	98	68
7	190	87	4.	5.	5.4	3.9	74	92	72
5	205	99	4.	5.4	5.7	3.9	70	94	68
1	200	97	4.4	5.3	5.3	3.6	83	100	67
2	209	90	3.7	4.75	5.1	3.8	72	93	74
2	207	96	3.75	5.	5.2	3.3	72	96	63

85. Chinese, E.....	1.9	2.9	4.8	4.8	4.8	14.4	4.8	3.00	100	100	3.95	4.5
86. Maori .....	1.7	2.8	4.5	5.5	5.5	15.5	5.7	2.63	81	90	3.7	5.5
87. Hottentot Chief, E. ....	1.7	3.3	5.5	5.4	5.5	15.9	5.8	2.74	92	101	4.2	4.9
88. Carib, E. No. 62 .....	2.1	2.8	4.9	5.5	4.9	14.8	5.9	2.50	98	98	4.5	4.5
89. Synostotic French, E. No. 32 .....	1.4	3.5	4.4	4.7	4.4	13.5	5.5	2.70	93	93	3.7	4.2
90. E longated skull, E.N. ....	1.8	2.6	4.4	5.5	4.5	14.4	5.5	2.88	80	81	3.8	4.7
91. So-called Baker's skull, T. ....	2.5	3.7	5.7	4.9	5.3	15.9	5.2	3.05	116	108	4.1	4.5
92. Large British, T. ....	2.4	3.4	5.8	5.2	6.5	17.5	5.3	3.30	111	125	4.7	4.6
93. Hunchback Dwarf, E. ....	1.9	2.7	4.6	5.5	4.6	14.7	5.35	2.74	83	83	3.8	4.8
94. Idiot, E. ....	1.7	2.7	4.4	4.8	4.5	13.7	5.3	2.58	91	93	3.6	4.3
95. Compressed Chinook, E.N. ....	1.8	2.4	4.2	4.9	4.5	13.6	5.3	2.56	85	91	3.8	4.2
96. Flattened American, E. (Monro).....	1.5	2.4	3.9	4.1	3.8	11.8	4.95	2.38	95	92	3.5	3.5

4.3	4.2	91	97	107	100	110	117	120	117	111	77	85	1.45	2.55	2.05	126	139	167	190
5.	4.4	74	88	160	134	147	154	136	140	133	87	85	1.5	2.5	2.2	134	129	185	205
4.9	4.8	83	98	148	147	137	151	135	148	131	77	103	1.6	2.4	2.4	125	134	171	200
4.5	4.6	88	102	154	137	145	150	136	152	144	70	85	1.6	2.1	1.6	140	148	172	209
4.2	4.2	88	100	153	134	144	154	132	138	145	85	91	1.5	2.	1.9	144	143	179	207
4.7	4.	80	85	152	145	142	143	124	162	125	85	80	1.3	2.	2.	196	164	212	252
4.5	4.7	91	104	137	138	128	150	136	156	131	76	84	1.4	1.9	2.	139	133	186	215
4.6	5.4	102	117	154	126	149	152	134	152	120	84	91	1.6	2.1	2.1	126	135	169	203
4.8	4.1	79	83	153	143	142	151	128	151	133	85	89	1.5	2.2	2.1	136	126	190	215
4.3	4.1	83	95	142	141	140	154	132	147	144	67	97	1.4	2.2	2.2	141	148	173	204
4.2	4.2	90	100	137	146	160	144	124	153	142	79	90	1.55	2.15	1.8	144	158	166	203
3.5	3.6	100	102	136	140	160	151	121	150	159	77	86	1.35	1.85	1.85	144	158	166	203

7	190	87	4·	5·	5·4	3·9	74	92	72
5	205	99	4·	5·4	5·7	3·9	70	94	68
1	200	97	4·4	5·3	5·3	3·6	83	100	67
2	209	90	3·7	4·75	5·1	3·8	72	93	74
)	207	96	3·75	5·	5·2	3·3	72	96	63
2	252	104	4·1	5·2	5·1	3·8	80	101	74
3	215	104	4·5	5·6	5·9	4·45	76	95	75
)	203	88	4·	5·05	5·35	3·55	74	94	66
)	215	98	3·85	4·55	4·7	3·05	81	96	64
3	204	94	3·9	5·	5·4	3·65	72	92	67
3	203	83	3·3	4·4	4·9	3·3	67	89	67

List of Skulls measured.

(E. stands for Anatomical Museum, University of Edinburgh; E.N. for Natural-History Museum of that University; T. for Professor Thomson's Collection; and Q.C.G. for Queen's College, Galway.)

	Area.							Radial r					
	Occipital area.	Parietal area.	Frontal area.	Total area.	Proportion of occipital area to total area reckoned as 100.	Proportion of parietal area to total area reckoned as 100.	Proportion of frontal area to total area reckoned as 100.	Radius to occipital tuberosity.	To midoccipital point.	To occipito-parietal suture.	To midparietal point.	To fronto-parietal suture.	To midfrontal point.
	40	41	42	43	44	45	46	47	48	4 <sup>c</sup>	50	51	52
<b>FETAL SKULLS.</b>													
1. Four months old, wet	400	870	350	1620	24.69	53.7	21.6	.....	.....	.....	.....	.....	.....
2. Five months old, dry, Q.C.G.	900	2456	990	4346	20.70	56.52	22.77	.....	.....	.....	.....	.....	.....
3. Five months old, wet	1428	2442	1000	4870	29.32	50.14	20.53	.....	.....	.....	.....	.....	.....
4. Seven months old, dry, Q.C.G.	1797	3910	1485	7192	24.98	54.37	20.64	.....	.....	.....	.....	.....	.....
5. Eight months old, dry, E.	1733	4375	1462	7570	22.89	57.79	19.31	1.6	2	2.3	2.8	2.5	2.4
6. Eight months old, dry, Q.C.G.	2202	4696	1740	8638	25.49	54.36	20.14	.....	.....	.....	.....	.....	.....
Average	.....	.....	.....	.....	24.67	54.48	20.83	.....	.....	.....	.....	.....	.....
<b>AT BIRTH.</b>													
7. Recent Section	2667	4772	1650	9089	29.34	52.50	18.15	.....	.....	.....	.....	.....	.....
8. E. (Monro's) 1	2479	5112	2012	9603	25.81	53.23	20.95	1.7	2.4	2.8	3.1	2.9	2.9
9. E. (Monro's) 2	2526	5210	1920	9656	26.15	53.96	19.88	1.8	2.4	2.7	3.1	2.9	2.7
10. E. 498	2110	5137	1920	9167	23.01	56.04	20.94	1.5	2.1	2.5	2.9	2.9	2.8
11. E. 123 c	2617	4817	2040	9474	27.62	50.84	21.53	1.9	2.3	2.6	3.1	3	2.8
Average	.....	.....	.....	.....	26.38	53.31	20.29	.....	.....	.....	3.05	.....	.....
<b>AFTER BIRTH.</b>													
12. 1 year old, E. 123 b	4399	7880	2850	15129	29.07	52.09	18.83	2.5	3.1	3.4	3.9	3.5	3.2
13. 2½ years, girl, T.	5330	8828	3995	18153	29.36	48.63	22.00	2.5	3.2	3.6	4	3.7	3.6
14. 3 years, E. 133 a	5832	9667	4500	19999	29.16	48.33	22.50	2.9	3.4	3.6	4	3.9	3.8
15. 3 years, E. 123 b	5344	11925	4838	22107	24.17	53.94	21.88	2.6	3.4	3.8	4.3	4.3	4
16. 5 years, E. 133	6475	11002	5395	22872	28.39	48.02	23.58	2.8	3.7	3.9	4.3	4.1	4.1
17. 6 years, E. 115	6520	13388	5950	25858	25.21	51.77	23.01	2.8	3.7	4	4.6	4.5	4.3
18. 10 years, boy, E. 6	7742	13712	5850	27304	28.35	56.22	21.42	3.3	3.9	4.2	4.9	4.7	4.6
Average	.....	.....	.....	.....	27.67	50.42	21.57	.....	.....	.....	4.28	.....	.....
<b>FRENCH.</b>													
19. Male, E. No. 21	6662	11270	5962	23894	27.88	47.16	24.95	2.7	3.3	3.7	4.5	4.7	4.7
20. " E. No. 24	7280	11976	5090	24316	29.93	49.26	20.80	2.6	3.4	3.9	4.3	4.2	4.2
21. " E. No. 25	6880	12592	5400	24872	27.66	50.62	21.71	2.9	3.5	3.7	4.5	4.6	4.4
22. " E. No. 26	6650	12075	5460	24185	27.49	49.93	22.57	2.8	3.1	3.5	4.4	4.4	4.5
23. " E. No. 28	6732	11902	5052	23686	28.42	50.25	21.32	2.8	3.5	3.9	4.5	4.3	4.2
24. " E. Old Soldier	8428	12070	6095	26593	31.69	45.39	22.91	2.8	3.6	4.1	4.6	4.7	4.9
25. Female, E. No. 27	6537	11432	5397	23666	27.61	48.31	24.07	2.6	3.4	3.8	4.4	4.3	4.4
26. " E. No. 29	6602	12980	5300	24972	26.43	52.38	21.18	2.8	3.4	3.8	4.6	4.6	4.5
27. " E. No. 23	6827	11252	5482	23561	28.97	47.35	23.67	2.7	3.3	3.9	4.8	4.5	4.4
Average	6955	11949	5510	24416	28.45	48.96	22.57	.....	.....	.....	4.51	.....	.....
<b>GERMAN.</b>													
28. Male, E. No. 37	6677	12697	6370	25744	25.09	50.16	24.74	2.6	3.2	3.9	4.6	4.8	4.8
29. " E. No. 37 a	7590	13665	6109	27364	27.73	49.94	22.32	2.8	3.6	4.2	4.7	5	5
30. " E. No. 41	7342	12312	5720	25374	28.93	48.53	22.53	3	3.6	3.9	4.5	4.4	4.6
31. " E. No. 42	6944	12085	6300	25329	27.41	47.71	24.87	2.8	3.5	4	4.8	4.8	4.8
32. " E. No. 43	7027	13775	6975	26877	26.18	51.21	22.60	2.9	3.5	3.8	4.7	4.8	4.7
33. Female, E. No. 38	6407	12565	5500	24472	26.18	50.93	22.88	2.6	3.2	3.7	4.7	4.7	4.7
34. " E. No. 39	6297	10897	4655	21849	28.81	49.88	21.30	2.5	3.3	3.7	4.3	4.3	4.5
35. " E. No. 40	6203	11260	5100	22563	27.48	49.91	22.60	2.6	3.2	3.5	4.2	4.3	4.4
Average	6810	12407	5728	24946	27.22	49.78	22.98	.....	.....	.....	4.56	.....	.....
<b>SCOTCH.</b>													
36. George Buchanan, E.	6616	10500	5145	22261	29.72	47.16	23.11	2.8	3.4	3.7	4.4	4.3	4.3
37. From Kilsyth, E. (Ballingall's) B. VII*	6073	9927	5145	21145	28.72	46.94	24.33	2.7	3.3	3.7	4.2	4.4	4.2
38. Edmunds, E.	8705	13600	5830	28135	30.94	48.33	20.72	2.95	3.65	3.95	4.6	4.75	4.65
39. Haggart, E.	7482	13709	6352	27543	27.16	49.77	23.06	3	3.7	4	4.8	4.7	4.7
40. Old Officer, E. (Ballingall's) B. VI	7918	14797	6090	28715	27.57	51.53	20.89	3.1	3.9	4.2	4.8	5	4.7
41. Male, set. 20, T.	7140	13777	6135	27052	26.39	50.93	22.67	2.0	3.7	4.1	4.8	4.5	4.5
42. Female, middle aged, E.	8394	13712	5348	27454	32.59	47.93	19.47	3.3	4.1	4.3	4.6	4.4	4.3
43. " set. 18, T.	6980	13830	5750	26560	26.46	51.89	21.64	2.7	3.6	4	4.6	4.6	4.5



RAL TABLE OF MEASUREMENTS (continued).

Radial measurements from postauricular depression.

					Proportion to midparietal radius reckoned as 100.																	
	To midfrontal point.	To glabellar prominence.	To fronto-nasal suture.	To nasal spine.	Radius to tuberosity.	Midoceipital radius.	Occipito-parietal radius.	Fronto-parietal radius.	Midfrontal radius.	Glabellar radius.	Fronto-nasal radius.	Radius to nasal spine.	Naso-basilar angle.	Naso-basilar line, from spheno-occipital suture to nasal spine.	Facial length, from fronto-nasal suture to nasal spine.	Index angle of prognathism.	Facial angle, modification of Camper's.	Vertical height of postauricular depression above foramen magnum.	Distance forwards and backwards of postauricular depression from front of foramen magnum (distance backwards marked -).	Length of skull from midoccipital point to fronto-nasal suture.		
1	52	53	54	55	56	57	58	59	60	61	62	63	64	65	66	67	68	69	70	71		
.....	.....	.....	.....	.....	.....	.....	.....	.....	.....	.....	.....	.....	154	65	35	90	°	.....	.....	1.6		
.....	.....	.....	.....	.....	.....	.....	.....	.....	.....	.....	.....	.....	163	1.1	6	79	.....	.....	.....	2.7		
.....	.....	.....	.....	.....	.....	.....	.....	.....	.....	.....	.....	.....	131	1.2	65	88	.....	.....	.....	2.95		
.....	.....	.....	.....	.....	.....	.....	.....	.....	.....	.....	.....	.....	152	1.4	7	87	.....	.....	.....	3.6		
5	2.4	2.2	1.9	2.	57	71	82	89	85	78	67	71	141	1.5	7	86	.....	.....	.....	3.7		
.....	.....	.....	.....	.....	.....	.....	.....	.....	.....	.....	.....	.....	143	1.5	8	88	.....	.....	.....	3.9		
.....	.....	.....	.....	.....	.....	.....	.....	.....	.....	.....	.....	.....	147	.....	.....	86	.....	.....	.....	.....		
.....	.....	.....	.....	.....	.....	.....	.....	.....	.....	.....	.....	.....	149	1.7	8	81	.....	.....	.....	4.1		
9	2.9	2.7	2.2	2.3	54	77	90	93	93	87	70	74	150	1.8	85	83	73	15	-.05	4.2		
9	2.7	2.5	2.2	2.3	58	77	87	93	87	80	70	74	147	1.7	9	85	72	2	-.1	4.2		
9	2.8	2.5	2.2	2.3	51	72	86	100	96	86	75	79	144	1.65	85	88	73	3	-.2	4.		
.....	2.8	2.5	2.1	2.1	61	74	83	96	90	80	67	67	135	1.5	8	85	77	1	-.15	4.1		
.....	.....	.....	.....	.....	56	75	86	95	91	83	70	73	145	1.67	84	84	73	18	-.12	4.12		
.....	.....	.....	.....	.....	.....	.....	.....	.....	.....	.....	.....	.....	.....	.....	.....	.....	.....	.....	.....	.....		
5	3.2	3.	2.5	2.5	64	79	87	89	82	76	64	64	129	1.9	1.05	85	75	3	-.05	5.3		
7	3.6	3.3	2.8	2.8	62	80	90	92	90	82	70	70	136	2.	1.1	91	76	55	-.2	5.7		
9	3.8	3.6	3.1	3.2	72	85	90	97	95	90	77	80	144	2.3	1.4	84	71	5	-.1	6.1		
3	4.	3.7	3.	2.9	60	79	88	100	93	86	69	67	130	2.	1.25	90	81	6	-.15	6.1		
1	4.1	4.	3.2	3.1	65	86	90	95	95	93	74	72	131	2.2	1.4	85	78	5	-.25	6.6		
5	4.3	3.7	3.2	3.2	60	80	86	97	93	80	69	69	126	2.3	1.5	86	77	7	-.1	6.7		
7	4.6	3.9	3.6	3.6	67	79	85	95	93	79	73	73	131	2.5	1.65	85	76	65	-.25	7.1		
.....	.....	.....	.....	.....	64	81	88	95	91	83	70	70	132	.....	.....	86	76	54	-.15	.....		
.....	.....	.....	.....	.....	.....	.....	.....	.....	.....	.....	.....	.....	.....	.....	.....	.....	.....	.....	.....	.....		
7	4.7	4.3	4.1	4.3	60	73	82	104	104	95	91	95	147	3.1	2.05	75	71	45	-.1	6.8		
2	4.2	4.	3.8	4.2	60	79	90	97	97	93	88	97	130	3.1	2.2	78	66	85	-.05	7.		
6	4.4	3.9	3.8	3.9	64	77	82	102	97	86	84	86	124	2.75	1.95	84	71	8	-.2	7.		
4	4.5	4.	3.9	3.9	63	70	79	100	102	90	88	88	133	2.95	2.05	88	73	7	-.1	6.75		
3	4.2	3.7	3.5	3.6	62	77	86	95	93	82	77	80	111	2.75	2.	80	70	7	-.25	6.65		
7	4.9	4.6	4.4	4.4	60	78	87	102	106	100	95	95	141	3.2	2.1	75	74	45	-.25	7.5		
3	4.4	4.2	3.7	3.8	59	77	86	97	100	95	82	86	136	2.9	1.8	82	75	4	0	6.8		
6	4.5	3.8	3.5	3.6	60	73	82	100	97	82	76	78	129	2.55	1.8	81	74	7	-.15	6.55		
5	4.4	3.9	3.6	3.7	56	68	81	93	91	81	75	77	130	2.75	1.95	79	71	6	-.1	6.3		
.....	.....	.....	.....	.....	60	75	83	98	98	89	84	86	131	2.89	1.98	80	71	62	-.11	6.81		
.....	.....	.....	.....	.....	.....	.....	.....	.....	.....	.....	.....	.....	.....	.....	.....	.....	.....	.....	.....	.....		
8	4.8	4.3	4.	4.1	56	69	84	104	104	97	86	87	132	2.95	2.	83	72	4	-.4	6.9		
4	5.	4.4	4.1	4.	59	76	89	106	105	93	87	85	131	2.9	2.05	84	80	25	-.2	7.3		
8	4.6	4.3	3.9	3.9	66	80	86	97	102	95	86	86	133	2.8	1.9	79	75	7	-.1	7.15		
8	4.8	4.1	3.9	4.1	58	72	83	100	100	85	81	85	132	3.1	2.	71	71	4	-.1	7.		
8	4.7	4.	3.7	3.7	61	74	80	102	100	85	78	78	120	2.65	2.05	80	75	65	-.2	6.9		
7	4.7	4.2	4.	3.6	55	68	78	100	100	89	85	76	124	2.3	1.95	85	85	45	-.5	6.8		
3	4.5	4.1	3.7	3.8	58	76	86	100	104	95	86	88	132	2.8	1.8	79	75	2	-.15	6.6		
3	4.4	4.	3.7	3.9	61	76	83	102	104	95	88	92	138	2.8	2.	75	70	6	-.2	6.5		
.....	.....	.....	.....	.....	59	73	83	101	102	91	84	84	130	2.78	1.96	79	75	45	-.23	6.86		
.....	.....	.....	.....	.....	.....	.....	.....	.....	.....	.....	.....	.....	.....	.....	.....	.....	.....	.....	.....	.....		
3	4.3	4.	3.8	3.7	63	77	84	97	97	90	86	84	.....	2.6	1.75	84	78	.....	.....	6.7		
4	4.2	3.8	3.5	3.9	64	78	88	104	100	90	83	92	124	2.8	1.9	75	65	8	-.2	6.4		
75	4.65	4.15	4.	4.1	64	79	85	103	101	90	86	89	128	3.	2.2	79	72	9	-.05	7.3		
7	4.7	4.1	3.8	4.	62	77	83	97	97	85	79	83	127	2.9	1.95	83	71	7	-.2	7.1		
4	4.7	4.1	3.8	3.5	66	81	87	104	97	85	79	72	116	2.4	2.1	87	80	6	-.3	7.4		
5	4.5	3.9	3.7	4.	60	77	85	93	93	81	77	83	129	3.15	2.	81	68	9	-.05	7.1		
4	4.3	3.7	3.5	3.5	71	89	93	95	93	80	76	76	128	2.7	1.95	84	73	8	-.2	7.3		
6	4.5	4.	3.8	4.1	58	78	86	100	97	86	83	89	141	3.	2.1	75	68	85	0	7.1		

	ricular depression from front of foramen magnum (distance backwards marked -).	Length of skull from midoccipital point to fronto-nasal suture.	Height of skull from front of foramen magnum parallel to line of frontal depth.	Proportion of height to length reckoned as 100.	Proportion of height to frontal depth reckoned as 100.	Greatest breadth.	Proportion of breadth to length reckoned as 100.	Angle between the plane of the foramen magnum and a plane touching the condyles and the part of the skull behind the foramen.	Angle between the line of orbital depth and the plane touching the condyles and the skull behind the foramen magnum.
70	71	72	73	74	75	76	77	78	
.....	1.6	1.5	93	142			°	°	
.....	2.7	2.1	77	121	2.2	81			
.....	2.95	2.3	77	148					
.....	3.6	2.8	77	133	3.	83			
-1	3.7	3.	81	141	3.1	83	8	19	
.....	3.9	3.3	84	146					
.....	.....	.....	81	138					
.....	4.1	3.2	78	160					
-.05	4.2	3.3	78	150	3.6	85	9	16	
-1	4.2	3.3	78	150	3.5	83	8	7	
-2	4.	3.3	82	150	3.3	82	2	14	
-.15	4.1	3.3	80	143	3.5	85	6	9	
-12	4.12	3.28	79	150	3.47	83	6	11.5	
-.05	5.3	4.	75	148	4.3	81	8	13	
-2	5.7	4.3	75	143	4.6	80	8	6	
-1	6.1	4.5	73	138	4.9	80	12	9	
-.15	6.1	4.9	80	136	5.2	85	4	2	
-.25	6.6	4.8	72	133	5.5	83	5	2	
-1	6.7	5.2	77	136	5.7	85	9	7	
-.25	7.1	5.5	77	142	5.7	80	9	8	
-15	.....	.....	75	139	.....	82	7	5.5	
-1	6.8	5.	73	135	6.1	89	18	13	
-.05	7.	5.1	72	150	5.6	80	14	15	
-2	7.	5.3	75	143	5.8	82	17	14	
-1	6.75	5.1	75	145	5.5	81	15	9	
-.25	6.65	5.2	78	148	5.4	82	13	11	
-.25	7.5	5.1	68	139	6.	80	11	15	
0	6.8	4.8	70	130	5.5	80	9	0	
-.15	6.55	5.3	80	147	5.3	80	13	5	
-1	6.3	5.3	84	151	5.7	90	12	6	
-11	6.81	5.13	75	143	5.65	82	13	9	
-.4	6.9	5.1	73	137	6.4	92	4	5	
-2	7.3	5.1	70	132	6.3	86	18	6	
-1	7.15	5.15	72	147	6.1	85	11	8	
-1	7.	5.2	74	135	6.1	87	16	10	
-2	6.9	5.4	76	140	6.	86	16	10	
-.5	6.8	5.1	75	141	5.8	85	12	12	
-.15	6.6	4.6	69	141	5.7	86	4	6	
-2	6.5	4.8	73	143	5.5	84	10	6	
-23	6.89	5.06	72	139	5.95	86	11	6	
.....	6.7	5.1	.....	.....	5.5	82			
-2	6.4	5.1	79	145	5.5	85	12	15	
-.05	7.3	5.6	76	150	5.7	78	19	15	
-2	7.1	5.5	77	144	5.5	77	20	12	
-3	7.4	5.5	74	134	6.2	83	7	3	
-.05	7.1	5.6	78	147	5.5	77	10	12	
-2	7.3	5.3	72	147	6.2	85	13	10	
0	7.1	5.5	77	148	.....	.....	9	6	

40. Old Officer, E. (Ballingall's) B. VI.	7-918	14-797	6-090	28-715	27-57	51-53	20-89	3-1	3-9	4-2	4-8	5-	4-7
41. Male, set. 20, T.	7-140	13-777	6-135	27-052	26-39	50-93	22-67	2-0	3-7	4-1	4-8	4-5	4-5
42. Female, middle aged, E.	8-394	13-712	5-348	27-454	32-59	47-93	19-47	3-3	4-1	4-3	4-6	4-4	4-3
43. " set. 18, T.	6-980	13-830	5-750	26-560	26-46	51-89	21-64	2-7	3-6	4-	4-6	4-6	4-5
Average	7-413	12-981	5-713	26-108	28-69	49-31	21-98	.....	.....	.....	4-6	.....	.....
GREEK.													
44. From Corfu, E. No. 45	5-360	12-617	5-590	23-567	22-74	53-54	23-71	2-4	3-	3-5	4-4	4-7	4-7
45. " E. (Monro's)	7-969	13-260	5-405	26-634	29-92	49-78	20-29	2-7	3-1	3-7	4-5	4-9	4-8
46. E. (Ballingall's) B. III.	7-600	13-318	6-300	27-218	27-92	48-93	23-14	3-	3-7	4-	4-6	4-6	4-8
47. " B. IV.	6-485	11-812	5-880	24-177	26-82	48-85	24-32	2-8	3-1	3-5	4-5	4-7	4-6
48. E. " B. V.	7-262	12-900	5-565	25-727	28-26	50-10	21-63	2-6	3-4	4-	4-6	4-6	4-4
Average	6-935	12-781	5-750	25-464	27-13	50-25	22-61	.....	.....	.....	4-56	.....	.....
IRISH.													
49. Male, Hurley, Q.C.G.	7-565	15-116	7-320	30-001	25-21	50-39	24-39	2-6	3-3	3-7	4-5	4-9	5-2
50. " Lydon, Q.C.G.	6-492	12-555	5-355	24-402	26-60	51-45	21-94	2-9	3-7	4-1	4-5	4-3	4-3
51. " From Ballinasloe, old, Q.C.G.	8-005	13-365	6-227	27-597	29-00	48-43	22-56	3-	3-6	3-8	4-4	4-5	4-7
52. " From Claregalway, Q.C.G.	8-299	12-137	5-850	26-286	31-60	46-14	22-25	3-	3-5	3-8	4-4	4-7	4-7
53. " " "	6-466	15-387	6-960	28-813	22-46	53-38	24-15	2-8	3-7	4-1	4-7	4-6	4-5
54. " " "	8-942	12-497	5-830	27-269	32-82	45-80	21-37	3-	3-7	4-1	5-	5-	4-9
55. Female " "	7-175	13-064	6-210	26-449	27-12	49-40	23-47	3-	3-7	4-2	4-7	4-7	4-7
56. " " "	6-674	11-805	5-227	23-706	28-15	49-80	22-04	3-1	3-7	3-9	4-3	4-2	4-3
57. " " "	7-465	12-555	5-160	25-180	29-64	49-86	20-49	3-1	3-9	4-1	4-6	4-2	4-2
Average	7-453	13-164	6-015	26-633	28-06	49-40	22-51	.....	.....	.....	4-56	.....	.....
HINDOO.													
58. E. No. 48	6-705	12-585	6-600	25-890	25-89	48-61	25-49	2-6	3-2	3-6	4-5	4-6	4-6
59. E. No. 49	6-927	11-767	5-355	24-049	28-80	48-93	22-26	2-6	3-2	3-8	4-6	4-6	4-4
60. E.N.	7-077	13-055	6-160	26-292	26-91	49-66	23-42	2-8	3-3	3-7	4-5	4-7	4-6
Average	6-903	12-469	6-038	25-410	27-20	49-06	23-72	.....	.....	.....	4-53	.....	.....
NEGRO.													
61. Male, E. No. 3	6-557	14-121	5-610	26-288	24-94	53-71	21-34	3-1	3-6	3-9	4-4	4-5	4-6
62. " E. No. 52	6-457	12-362	5-912	24-731	26-18	49-91	23-90	2-6	3-1	3-4	4-3	4-4	4-7
63. " E. No. 53	7-399	13-305	5-460	26-164	28-27	50-86	20-86	3-	3-6	4-	4-4	4-5	4-5
64. " E. No. 54	6-964	12-180	6-300	25-444	27-36	47-87	24-73	2-8	3-4	3-8	4-4	4-7	4-6
65. " E. No. 55	9-115	12-065	6-555	27-735	32-86	43-50	23-63	2-6	3-8	4-4	5-1	5-1	5-
66. Female, E. No. 56	7-199	12-802	6-555	26-536	27-18	48-13	24-68	2-8	3-3	3-7	4-4	4-7	4-8
67. " set. 15, E. (Monro's)	6-737	12-282	5-460	24-479	27-52	50-17	22-30	3-0	3-7	4-1	4-6	4-4	4-4
Average	7-204	12-731	5-978	25-913	27-75	49-16	23-06	.....	.....	.....	4-51	.....	.....
KAFIR.													
68. Male, E. No. 59	8-603	15-945	6-462	31-010	27-74	51-42	20-83	2-9	3-8	4-4	5-1	5-2	4-9
69. " E. (Monro's)	8-006	13-464	6-555	28-025	28-56	48-04	23-39	3-1	3-7	4-	4-5	4-7	4-7
70. " E. (Dr. Black's)	7-153	14-420	6-187	27-760	25-76	51-95	22-28	3-	3-5	3-9	4-6	4-7	4-8
71. Female, E.	7-000	11-962	5-460	24-422	28-66	48-98	22-35	2-8	3-4	3-8	4-4	4-4	4-3
Average	7-690	13-947	6-166	27-804	27-68	50-09	22-21	.....	.....	.....	4-65	.....	.....
AUSTRALIAN.													
72. E.N.	6-875	13-005	6-300	26-180	26-26	49-67	24-06	2-9	3-5	3-8	4-4	4-6	4-5
73. E. No. 66	7-347	13-522	5-797	26-666	27-55	50-71	21-73	2-8	3-4	3-6	4-2	4-4	4-5
Average	7-111	13-263	6-048	26-423	26-90	50-19	22-89	.....	.....	.....	4-6	.....	.....
KANAKA.													
74. Male, E.	6-654	14-242	6-110	27-006	24-63	52-74	22-62	2-6	3-4	4-1	4-9	4-9	4-8
75. Female, E.	6-832	13-660	5-355	25-847	26-43	52-85	20-71	2-6	3-4	3-9	4-7	4-7	4-55
Average	6-743	13-951	5-732	26-426	25-53	52-79	21-66	.....	.....	.....	4-8	.....	.....
ESQUIMAUX.													
76. E. (Monro's)	7-634	12-354	5-720	25-708	29-69	48-06	22-24	2-8	3-5	3-8	4-4	4-5	4-6
77. E. 68 a	6-905	12-590	5-737	25-232	27-36	49-91	22-73	2-8	3-5	3-9	4-4	4-6	4-5
Average	7-224	12-472	5-728	25-470	28-52	48-98	22-48	.....	.....	.....	4-4	.....	.....
PERUVIAN.													
78. E.N.	6-065	11-145	4-500	21-710	27-93	51-34	20-72	2-3	2-9	3-5	4-5	4-6	4-2
79. E.N.	6-260	13-077	5-942	25-279	24-76	51-73	23-50	2-8	3-6	4-2	5-1	4-7	4-3
Average	6-162	12-111	5-221	23-494	26-34	51-53	22-21	.....	.....	.....	4-8	.....	.....
MISCELLANEOUS.													
80. Burke, E.	6-537	12-148	5-847	24-522	26-65	49-50	23-84	3-1	3-5	3-8	4-3	4-2	4-4
81. Spanish pirate, E. No. 33	7-032	13-785	5-625	26-442	26-59	52-13	21-27	2-6	3-3	3-8	4-4	4-6	4-9
82. Swiss, E. No. 34	7-335	12-006	5-850	25-191	29-11	47-66	23-22	3-	3-7	4-2	4-4	4-2	4-2
83. Turk, E. (Monro's)	6-695	11-805	5-250	24-750	27-13	51-65	21-21	2-5	3-3	3-7	4-3	4-2	4-4
84. Tartar, E. No. 46	8-585	10-876	5-460	24-921	34-44	43-65	21-90	2-8	3-6	4-2	4-5	4-5	4-5
85. Chinese, E.	7-674	12-394	4-725	24-693	30-67	50-19	19-13	2-8	3-5	3-9	4-4	4-3	4-2
86. Maori	6-529	15-190	6-160	27-879	23-41	54-49	22-09	3-	3-7	4-1	4-8	5-	4-8
87. Hottentot Chief, E.	8-502	15-520	6-960	30-982	27-44	50-09	22-46	3-	3-9	4-3	4-9	4-9	4-9
88. Carib, E. No. 62	8-830	13-287	5-980	28-097	31-42	47-29	21-28	3-3	3-9	4-2	4-6	4-4	4-4
89. Sinosotie French, E. No. 32	7-243	12-237	4-620	24-100	30-05	50-77	19-17	2-7	3-5	3-9	4-9	4-9	4-3
90. Elongated skull, E.N.	6-505	13-190	5-200	24-895	26-12	52-99	20-88	2-7	3-5	4-3	4-5	4-	4-4
91. So-called Baker's skull, T.	8-345	12-920	6-110	27-375	30-48	47-30	22-21	3-	4-2	4-5	4-8	4-6	4-6

47	41	38	35	66	81	87	104	97	85	79	72	116	24	21	87	80	-6	-3	74	
45	39	37	4	60	77	85	93	93	81	77	83	129	3-15	2	81	68	-9	-05	71	
4	43	37	35	71	89	93	95	93	80	76	76	128	27	195	84	73	-8	-2	73	
6	45	4	38	41	58	78	86	100	97	86	83	89	141	3	21	75	68	-85	0	71
.....	.....	.....	.....	.....	63	79	86	99	96	85	81	83	127	281	199	81	71	-78	-07	70
7	47	42	4	4	54	68	79	106	106	95	90	90	126	285	2	81	77	-5	-5	66
9	48	44	42	42	60	68	82	108	106	97	93	93	125	285	185	85	76	.....	.....	69
6	48	43	39	39	65	80	86	100	104	93	84	84	143	285	2	83	75	-8	0	72
7	46	39	36	37	62	68	77	104	102	86	80	82	119	285	21	86	73	-6	-05	64
6	44	4	39	4	56	73	86	100	95	86	84	86	136	29	195	75	70	-8	-1	69
.....	.....	.....	.....	.....	59	71	82	103	102	91	86	87	129	286	198	82	74	-7	-22	68
9	52	47	44	45	57	73	82	108	115	104	97	100	144	28	21	80	75	-8	-6	75
3	43	37	35	35	64	82	91	95	95	82	77	77	138	265	185	73	73	-5	0	69
5	47	44	41	42	68	81	86	102	106	100	93	95	128	275	22	79	71	-9	-2	74
7	47	43	4	41	68	79	86	106	106	97	90	92	131	285	185	80	71	-8	-25	72
6	45	41	37	37	59	78	87	97	95	87	78	78	134	26	18	80	78	-65	-05	72
7	49	41	38	37	60	74	82	100	98	82	76	74	137	27	19	85	77	-4	0	72
7	47	42	39	37	63	78	89	100	100	89	82	78	129	265	195	83	81	-3	-25	72
2	43	39	36	37	72	86	90	97	100	90	83	86	138	27	19	80	72	-4	-15	7
2	42	37	35	37	67	84	89	91	91	80	76	80	128	27	195	79	70	-7	0	71
.....	.....	.....	.....	.....	64	79	86	99	100	90	82	84	134	271	194	798	74	-60	-16	71
6	46	4	38	38	57	71	80	102	102	88	84	84	120	26	19	78	74	1	-4	66
6	44	37	35	37	56	69	82	100	95	80	76	80	125	275	18	81	72	-7	-25	64
7	46	41	39	42	62	73	82	104	102	91	86	93	130	315	2	79	67	-9	-2	68
.....	.....	.....	.....	.....	58	71	81	102	99	86	82	85	125	283	19	793	71	-86	-28	66
5	46	44	41	45	70	81	88	102	104	100	93	102	143	32	195	68	65	-7	-15	74
4	47	46	41	43	60	72	79	102	109	106	95	100	136	295	195	78	74	-9	-25	69
5	45	44	41	44	68	81	90	102	102	100	93	100	143	32	195	68	65	-8	-15	72
7	46	41	38	38	63	77	86	106	104	93	86	86	131	275	225	73	72	-85	-1	68
5	5	43	4	41	50	74	87	100	98	84	78	80	130	3	21	77	71	-5	-1	72
7	48	42	39	42	63	75	84	106	109	95	88	95	137	295	19	79	70	-85	-25	69
4	44	41	35	37	65	80	89	90	90	89	76	80	141	26	17	69	72	-6	-1	68
.....	.....	.....	.....	.....	62	77	86	101	102	97	87	91	137	295	197	731	69	-75	-15	70
5	49	45	41	43	56	74	86	101	96	88	80	84	140	31	215	76	72	-9	-25	75
7	47	42	39	42	68	82	88	104	104	93	86	93	134	3	2	70	70	-9	-2	73
7	48	43	41	44	65	76	84	102	104	93	89	95	134	32	195	74	68	-85	-2	74
4	43	4	38	4	63	77	86	100	97	90	86	90	144	28	22	78	70	-65	-05	67
.....	.....	.....	.....	.....	63	77	86	101	100	93	85	90	138	302	202	745	70	-82	-17	72
6	45	42	39	42	65	79	87	104	102	95	88	95	132	3	19	72	69	-95	0	72
4	45	41	39	42	66	80	85	104	107	97	92	100	138	305	165	75	70	-9	-15	71
.....	.....	.....	.....	.....	65	79	86	104	104	96	90	97	135	302	177	735	69	-92	-07	71
9	48	44	41	39	53	69	83	100	97	89	83	79	135	275	195	80	82	-65	-3	71
7	455	41	38	4	55	72	82	100	96	87	80	85	138	275	185	79	71	-7	-2	68
.....	.....	.....	.....	.....	54	70	82	100	96	88	81	82	136	275	190	795	76	-67	-25	69
5	46	41	39	42	63	79	87	102	104	93	88	95	135	285	2	75	68	-9	-35	7
6	45	43	4	41	63	79	88	104	102	97	90	93	141	29	21	78	74	-95	-2	71
.....	.....	.....	.....	.....	63	79	87	103	103	95	89	94	138	287	205	765	71	-92	-27	70
6	42	38	36	38	51	64	77	102	93	84	80	84	118	28	21	75	67	-65	-2	59
7	43	39	36	37	54	70	82	92	84	76	70	72	.....	255	175	75	73	.....	.....	67
.....	.....	.....	.....	.....	52	67	79	97	88	80	75	78	.....	267	192	75	70	.....	.....	63
2	44	41	39	4	72	81	88	97	102	95	90	93	126	3	185	78	74	-65	-15	72
6	49	45	43	45	59	75	87	104	111	102	97	102	128	31	21	80	73	-9	-6	73
2	42	39	37	39	68	84	95	95	95	88	84	88	133	295	19	79	71	-65	-1	67
5	44	4	38	4	58	76	86	97	102	93	88	93	131	28	21	78	70	-85	-25	67
5	45	41	38	39	62	80	93	100	100	91	84	86	125	275	21	80	73	-7	-2	69
3	42	38	36	38	63	79	88	97	95	87	81	86	121	26	205	76	68	-9	-3	68
5	48	42	39	38	62	77	85	104	100	87	81	79	141	28	185	75	79	-9	0	72
9	49	43	41	45	61	79	87	100	100	87	83	91	138	33	2	74	64	1	0	77
4	44	44	42	42	71	84	91	95	95	95	91	91	127	3	21	84	76	105	-25	78
9	43	37	35	38	55	71	87	100	87	75	71	77	131	275	21	73	68	-45	-1	64
4	44	4	38	36	60	77	86	88	97	88	84	80	132	245	175	88	81	-7	-2	7
6	46	42	4	39	62	87	93	95	95	87	83	81	156	295	2	86	77	-2	-15	78
9	49	44	41	41	64	79	88	98	98	101	77	77	122	29	19	79	74	-8	-35	78

-3	7·4	5·5	74	134	6·2	83	7	3
·05	7·1	5·6	78	147	5·5	77	10	12
·2	7·3	5·3	72	147	6·2	85	13	10
0	7·1	5·5	77	148	.....	.....	9	6
-07	7·07	5·41	76	145	5·72	80	12	10
-5	6·6	5·	75	135	5·3	80	11	16
.....	6·9	5·4	.....	.....	5·5	79		
0	7·2	5·5	75	142	5·5	78	8	16
·05	6·4	5·3	82	147	5·7	89	7	2
-1/	6·9	5·4	79	150	5·4	76	17	20
-22	6·8	5·32	77	143	5·48	80	10	13
-6	7·5	5·4	72	128	5·6	74	19	21
0	6·95	4·9	70	136	5·7	82	14	13
-2	7·4	5·35	71	144	6·	81	21	12
-25	7·2	5·3	73	147	5·5	76	13	9
-05	7·2	5·3	73	139	5·4	75	14	5
0	7·2	5·4	75	135	5·8	80	12	5
-25	7·2	5·	69	131	5·7	79	11	3
-15	7·	4·6	65	135	5·3	76	11	3
0	7·1	5·2	73	152	5·5	77	13	7
-16	7·19	5·16	71	138	5·61	77	14	8
-4	6·6	5·6	84	143	5·3	80	7	7
-25	6·4	5·4	84	150	5·4	84	7	6
-2	6·8	5·6	82	153	5·4	79	9	8
-28	6·6	5·53	83	148	5·36	81	7·6	7
-15	7·4	5·2	71	150	5·1	68	9	11
-25	6·95	5·2	74	150	5·1	73	19	23
-15	7·25	5·2	71	144	5·4	74	16	26
-1	6·8	5·3	77	139	5·1	75	6	12
-1	7·2	5·6	77	147	5·2	72	17	10
-25	6·9	5·4	78	142	5·1	73	6	15
-1	6·8	5·1	75	147	5·	73	11	15
-15	7·05	5·28	74	145	5·14	72	12	16
-25	7·5	6·1	81	145	5·3	70	11	26
-2	7·3	5·5	75	134	5·4	73	13	25
-2	7·4	5·5	74	144	5·3	71	6	10
-05	6·75	5·1	75	141	5·3	78	20	14
-17	7·21	5·55	76	141	5·32	73	12	18
0	7·2	5·35	74	146	5·2	72	9	9
-15	7·1	5·2	73	140	5·1	71	9	11
-07	7·15	5·27	73	143	5·15	71	9	10
-3	7·1	5·6	78	149	5·6	78	16	19
-2	6·8	5·35	78	152	5·3	77	17	8
-25	6·95	5·47	78	150	5·45	77	16·5	13·5
-35	7·	5·3	75	143	5·3	75	8	10
-2	7·15	5·3	74	139	5·7	79	9	25
-27	7·07	5·3	74	141	5·5	77	8·5	17·5
-2	5·9	5·2	88	152	5·6	98	18	15
.....	6·7	5·6						
.....	6·3	5·4						
-15	7·2	5·05	70	148	5·7	79	7	11
-6	7·3	5·4	74	154	5·	68	14	22
1	7·1	5·05	71	136	5·4	76	13	10
-25	6·75	5·1	75	150	5·2	77	15	21
-2	6·9	5·3	76	155	5·4	78	10	12
-3	6·8	5·3	77	151	5·7	83	13	15
0	7·2	5·9	81	151	5·6	77	10	23
0	7·7	5·9	76	151	5·2	67	16	11
-25	7·8	5·7	73	158	5·4	69	9	18
-1	6·4	5·3	82	139	.....	.....	15	23
-2	7·	5·	71	151	5·2	74	13	14
-15	7·8	4·5	57	118	6·2	78	11	5
-35	7·8	6·1	78	137				

87. Hottentot Cmer, E. ....	8-502	13-820	5-800	30-582	27-448	30-00	22-80	3	3-0	4-2	4-6	4-4	4-4
88. Carib, E. No. 62 .....	8-830	13-287	5-980	28-097	31-42	47-29	21-28	3-3	3-9	4-2	4-6	4-4	4-4
89. Synostotic French, E. No. 32 .....	7-243	12-237	4-620	24-100	30-05	50-77	19-17	2-7	3-5	4-3	4-9	4-9	4-3
90. Elongated skull, E.N. ....	6-505	13-190	5-200	24-895	26-12	52-99	20-88	2-7	3-5	3-9	4-5	4-4	4-4
91. So-called Baker's skull, T. ....	8-345	12-920	6-110	27-375	30-48	47-30	22-21	3-	4-2	4-5	4-8	4-6	4-6
92. Large British, T. ....	10-260	15-690	8-505	34-455	29-77	45-54	24-68	3-4	4-2	4-7	5-3	5-2	5-2
93. Hunchback Dwarf, E. ....	7-377	13-886	5-535	26-798	27-52	51-82	20-65	3-	3-7	4-	4-6	4-4	4-4
94. Idiot, E. ....	7-232	10-704	4-715	22-651	31-92	47-26	20-81	3-9	4-5	3-7	4-2	4-1	3-9
95. Compressed Chinook, E.N. ....	6-720	12-880	4-830	24-430	27-50	52-72	19-77	2-7	3-3	3-9	4-6	4-3	4-2
96. Flattened American, E. (Monro).....	5-537	9-784	3-690	19-011	29-12	51-47	19-40	2-3	3-	3-6	4-4	4-2	3-9

4.4	4.4	4.4	4.2	4.2	71	84	91	95	95	95	91	91	127	3	2.1	84	76	1.05	-25	7.8
4.9	4.3	3.7	3.5	3.8	55	71	87	100	87	75	71	77	131	2.75	2.1	73	68	.45	-1	6.4
4.	4.4	4.	3.8	3.6	60	77	86	88	97	88	84	80	132	2.45	1.75	88	81	.7	-2	7.
4.6	4.6	4.2	4.	3.9	62	87	93	95	95	87	83	81	156	2.95	2.	86	77	-.2	-15	7.8
5.2	5.2	4.4	4.1	4.1	64	79	88	98	98	101	77	77	122	2.9	1.9	79	74	.8	-35	7.8
4.4	4.4	4.	3.7	4.	65	80	86	95	95	86	80	86	126	2.9	2.15	80	67	1.05	-2	7.1
4.1	3.9	4.	3.7	4.	92	107	88	97	92	95	88	95	124	2.95	2.05	77	68	.85	.1	6.9
4.3	4.2	4.	3.8	4.2	58	71	84	93	91	86	82	91	136	2.9	2.1	70	65	.8	-25	6.6
4.2	3.9	3.8	3.7	4.	52	68	81	95	88	86	84	90	148	2.95	2.1	69	67	.4	-25	5.6

-25	7.8	5.7	73	158	5.4	09	9	15
-1	6.4	5.3	82	139	.....	.....	15	23
-2	7.	5.	71	151	5.2	74	13	14
-15	7.8	4.5	57	118	6.2	78	11	5
-35	7.8	6.1	78	137				
-2	7.15	5.5	76	154	5.4	75	11	22
.1	6.9	5.	72	163	5.	72	14	4
-25	6.65	5.4	81	147	5.2	78	14	21
-25	5.9	4.8	81	145	6.4	108	18	32



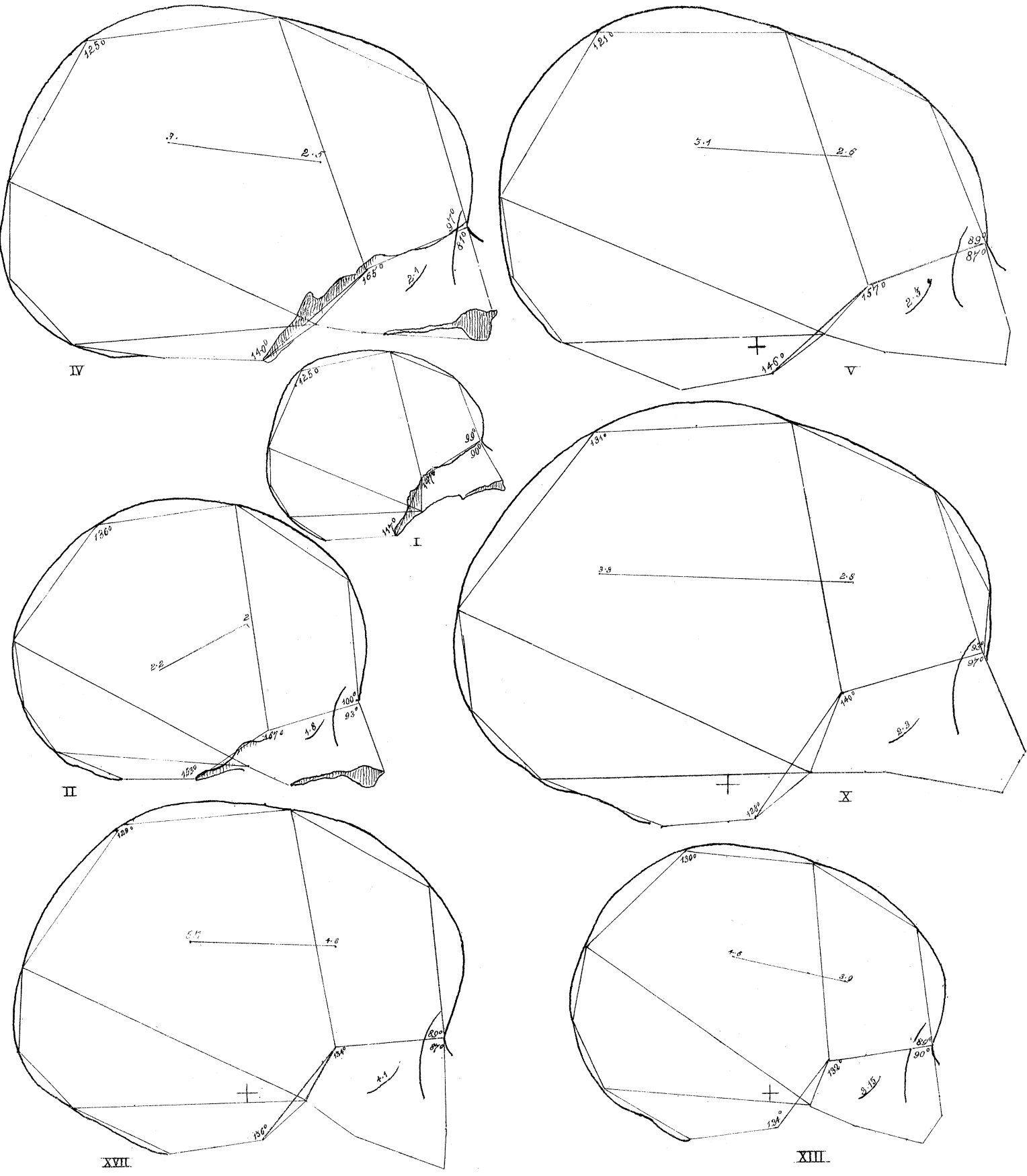

Skulls of Children before & after birth.  
(The first five are full size)

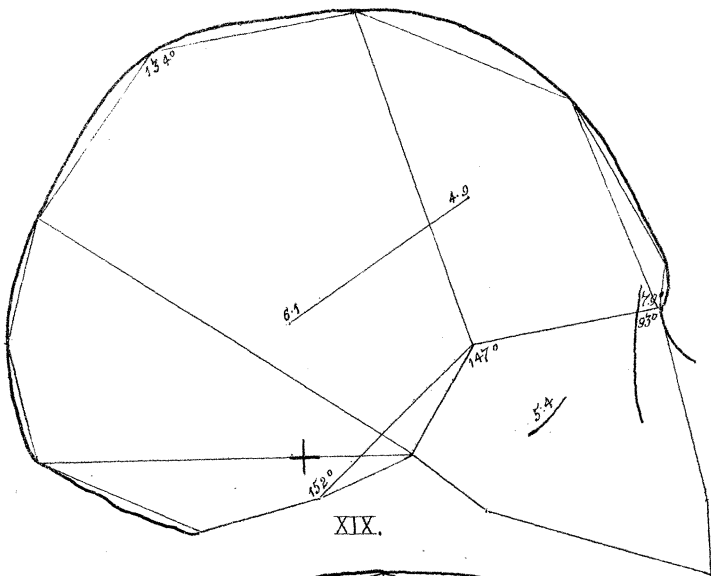

XIX.

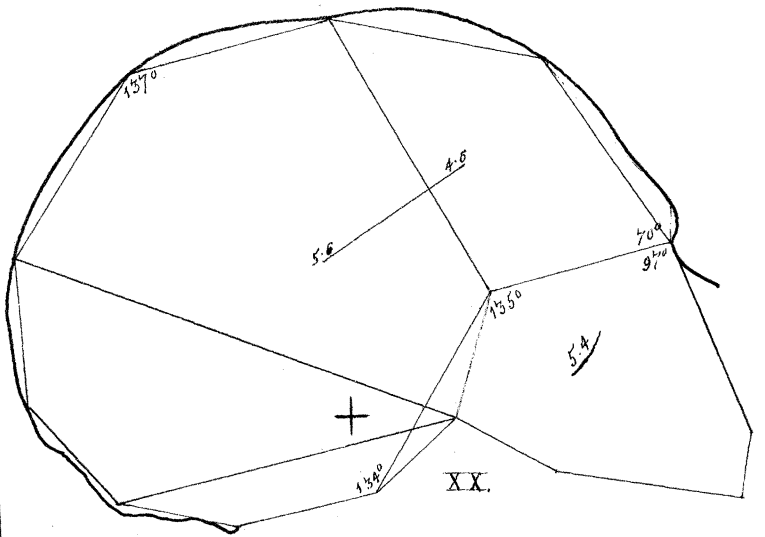

XX.

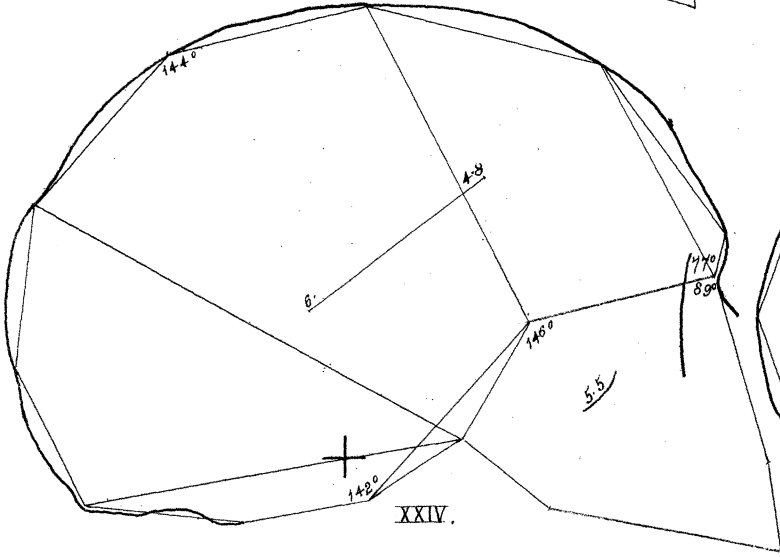

XXIV.

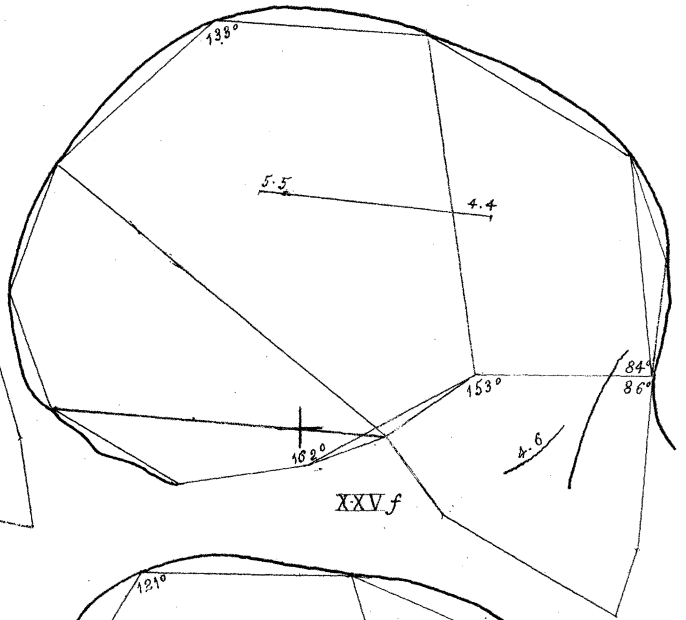

XXV.f

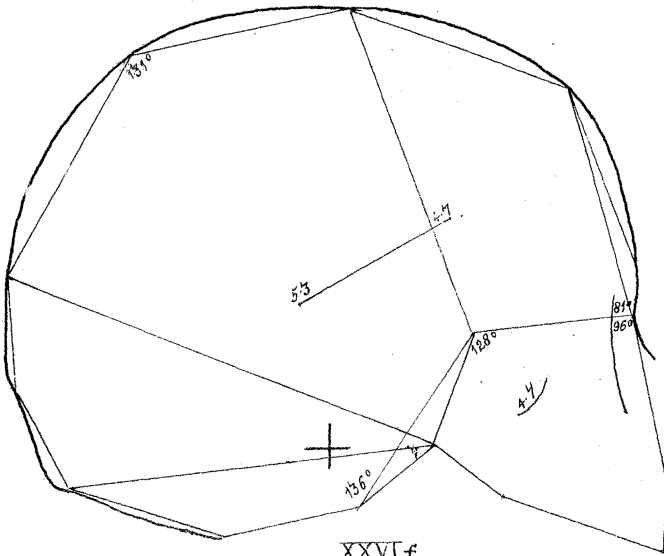

XXVI.f

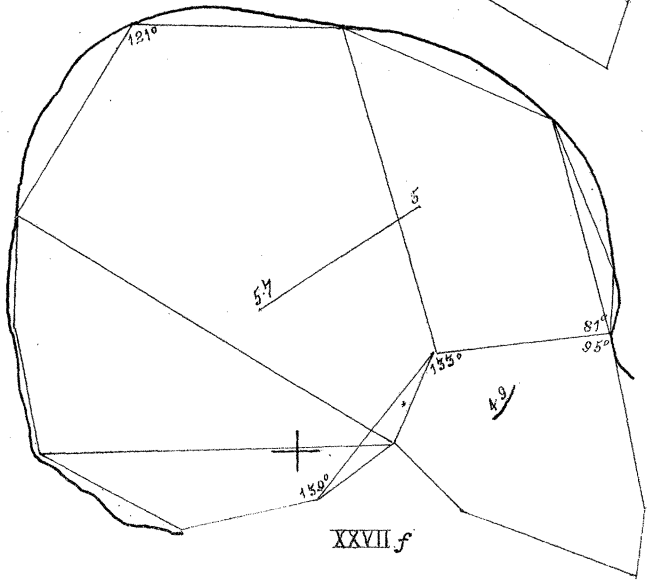

XXVII.f

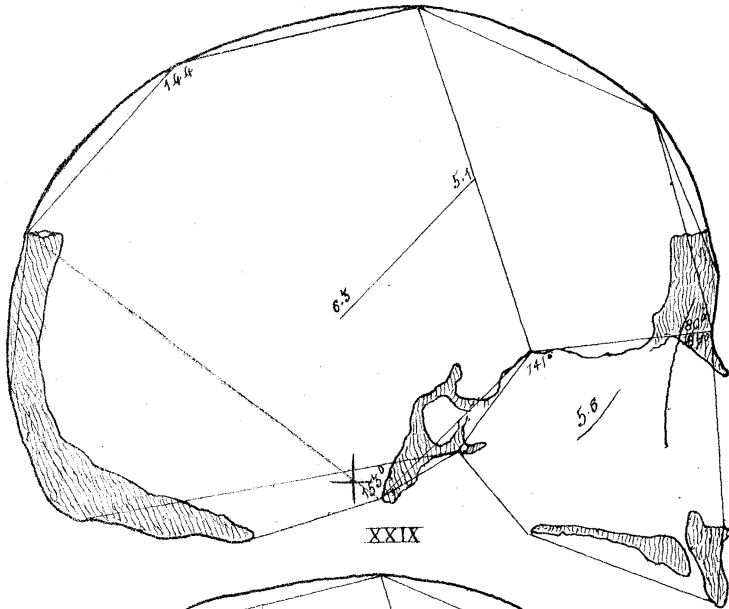

XXIX

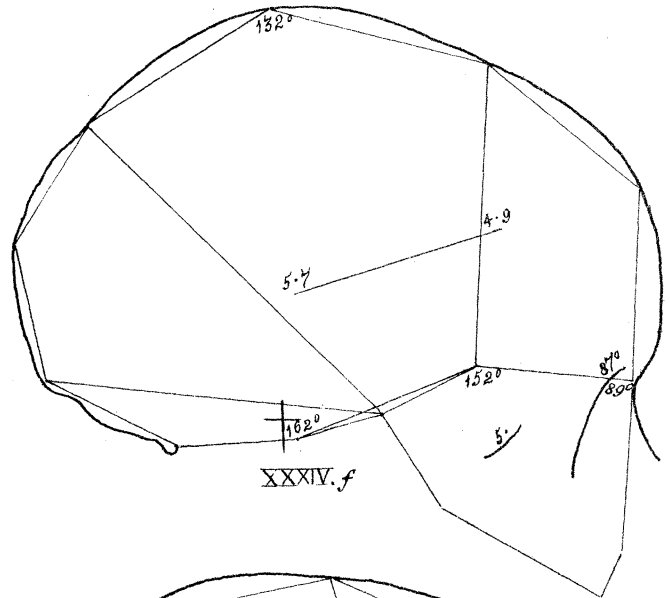

XXXIV.f

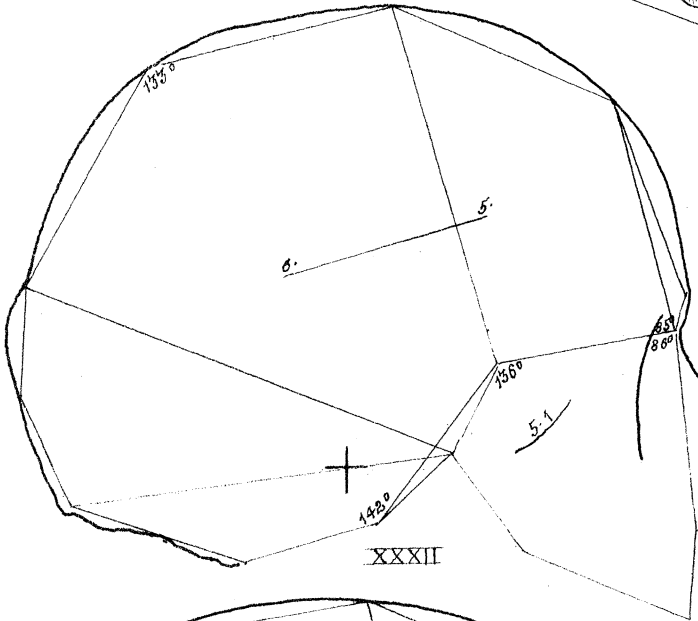

XXXII

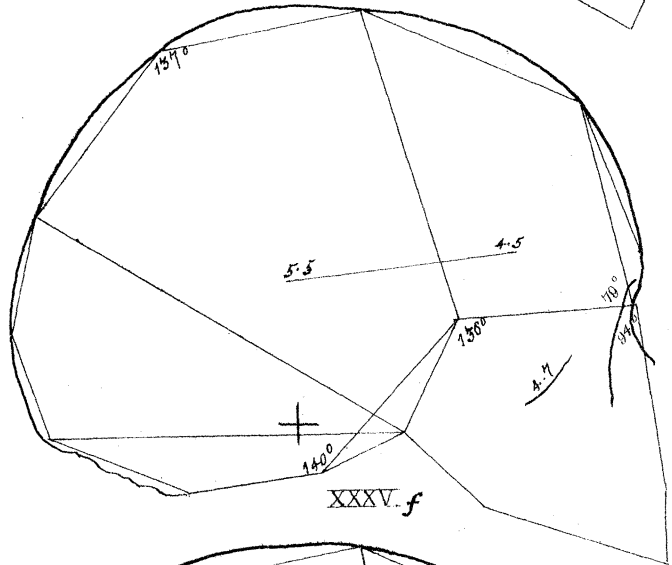

XXXV.f

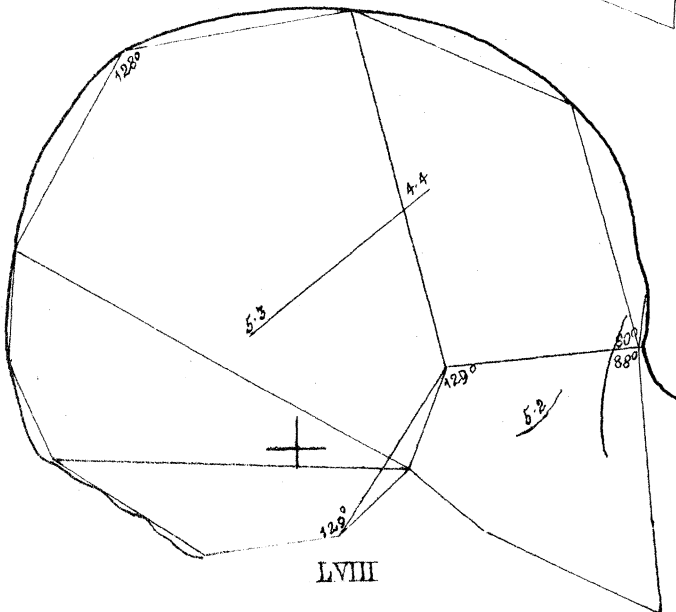

LVIII

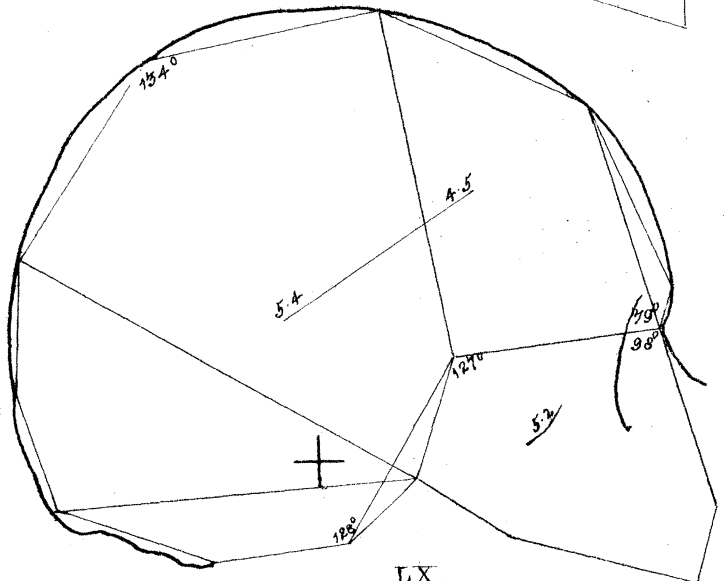

LX.

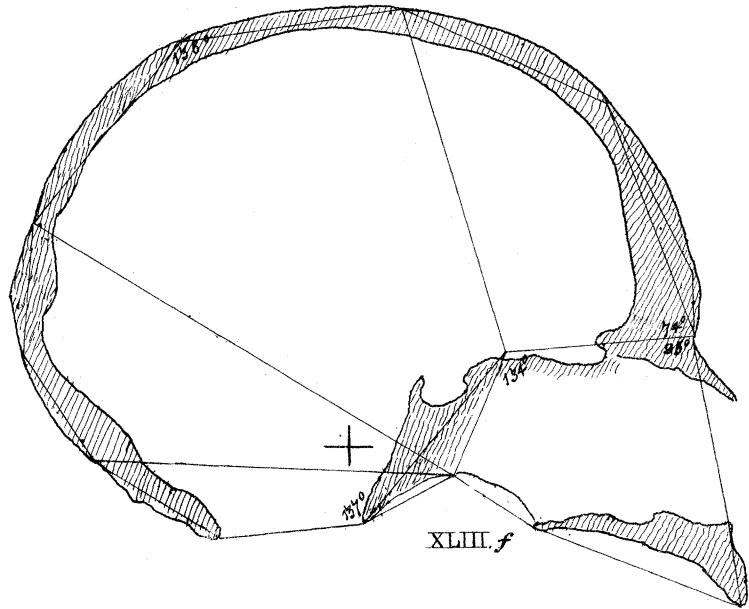
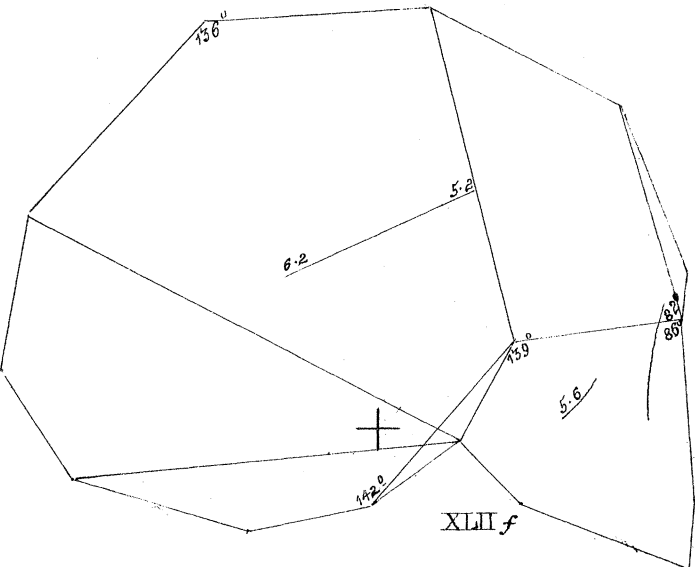
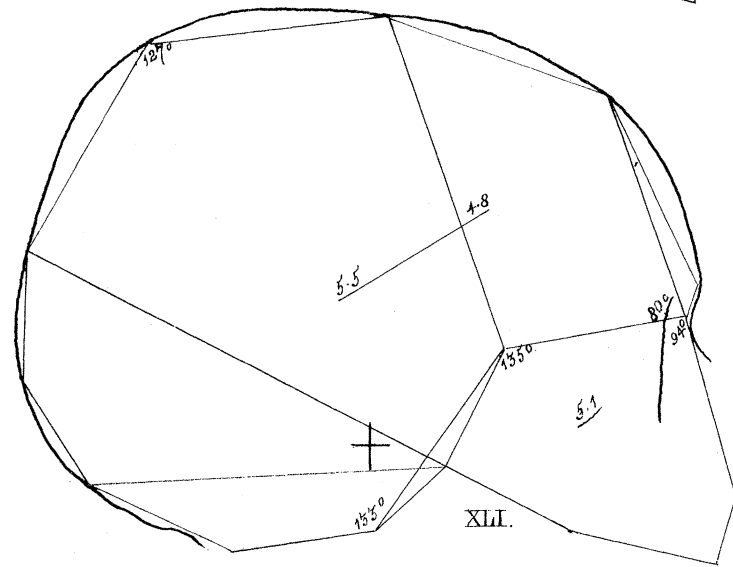
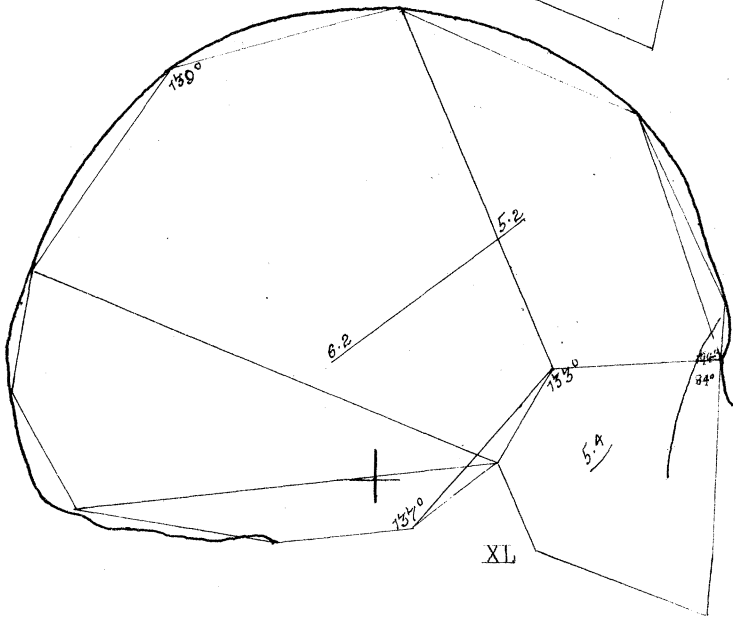
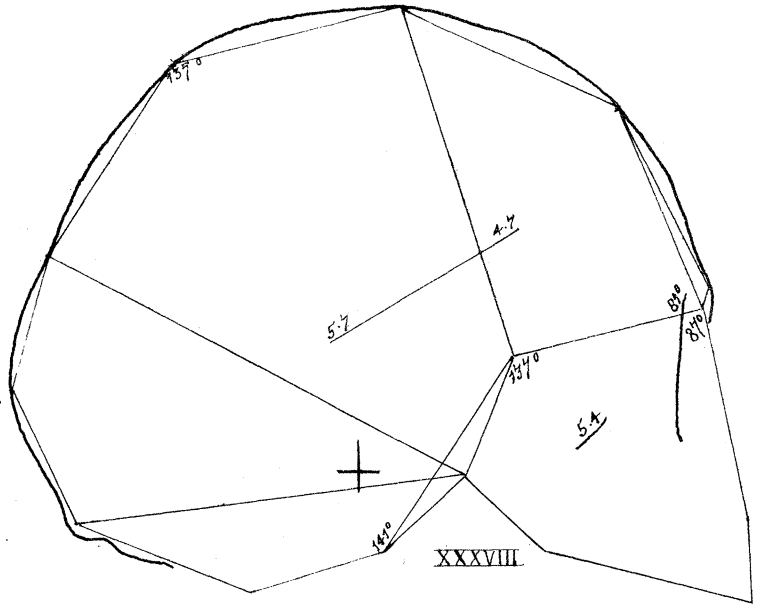
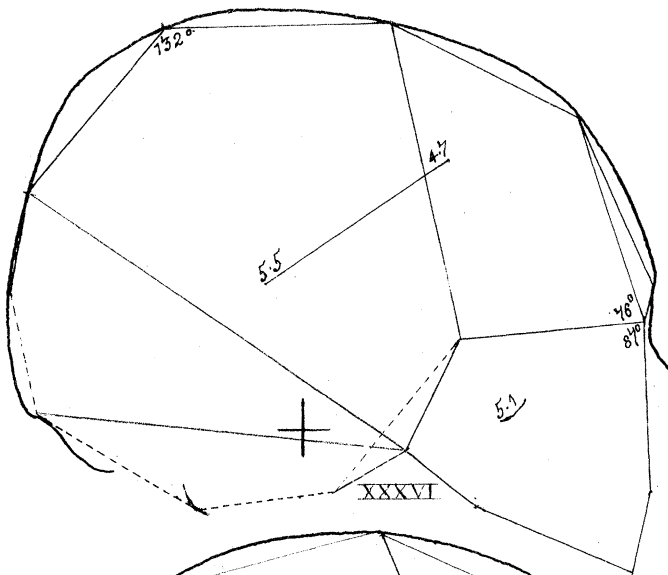

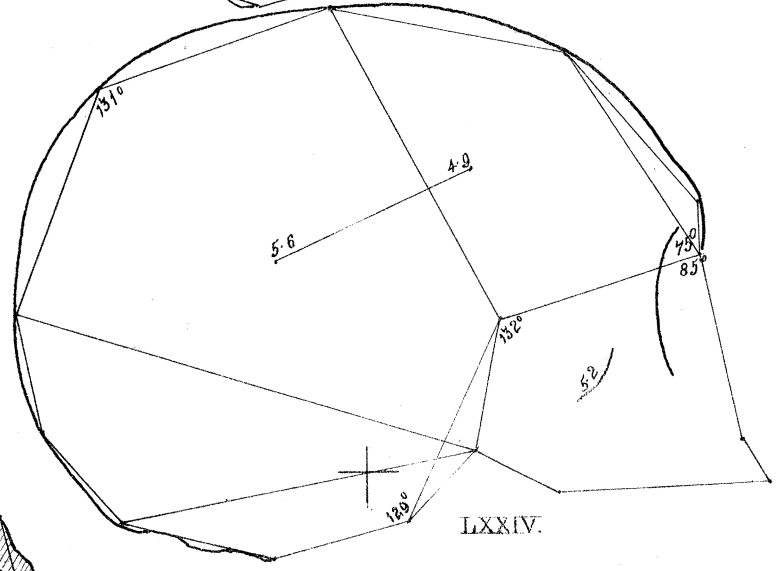
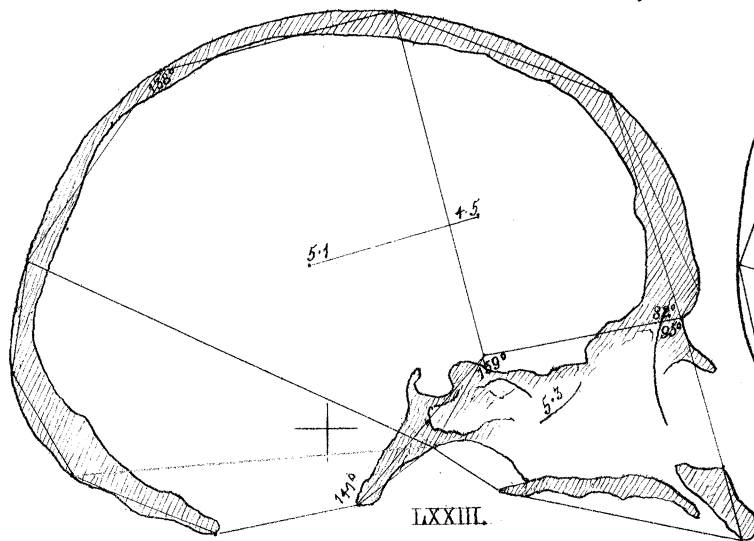
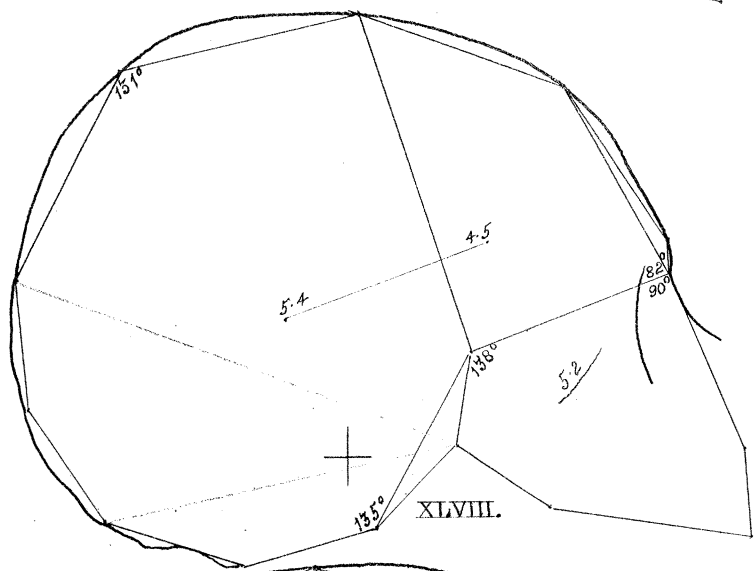
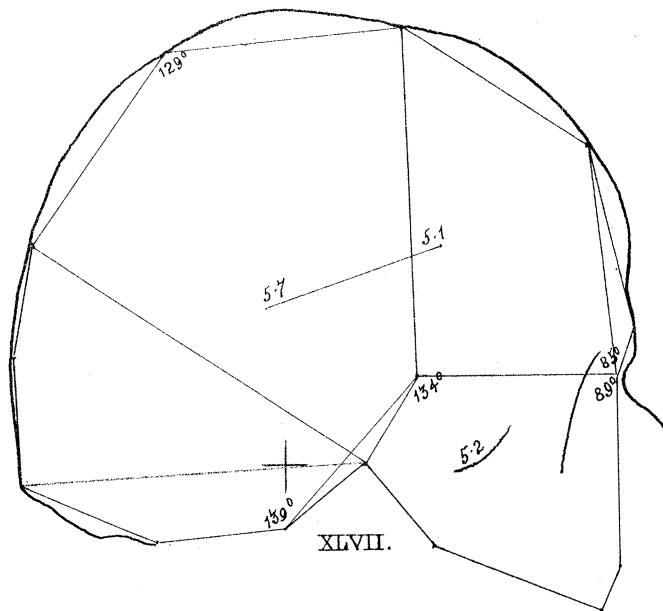
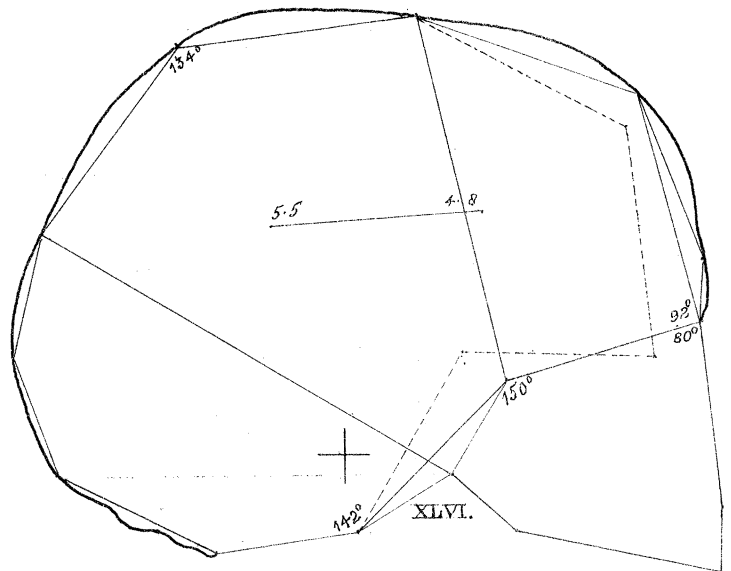
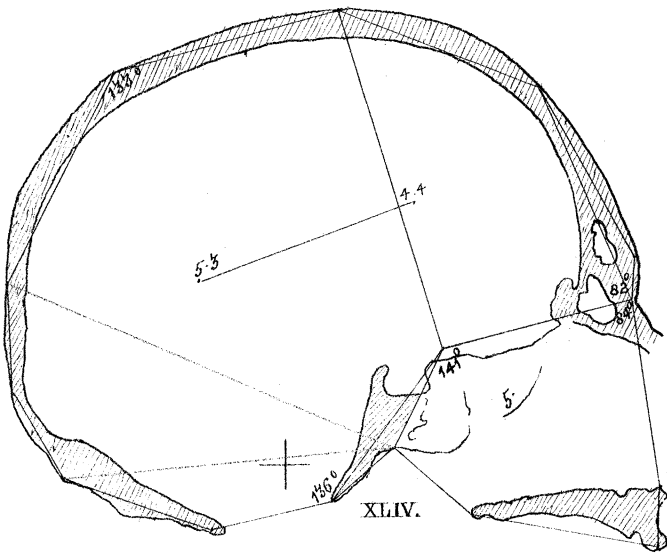

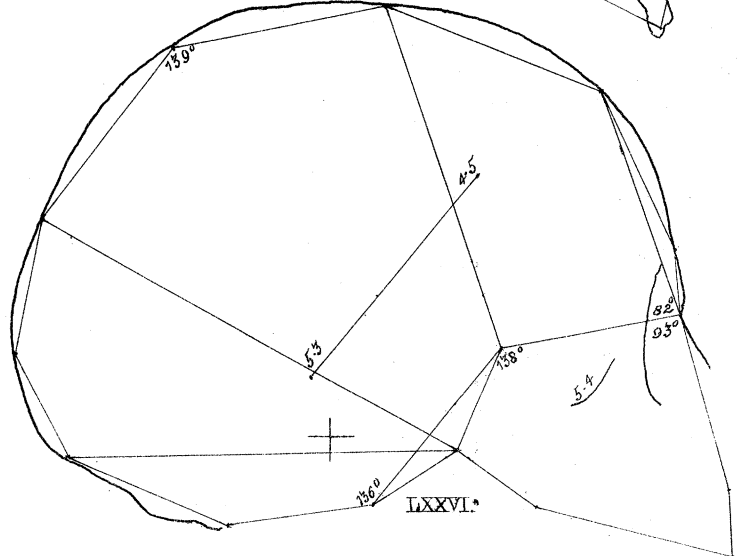
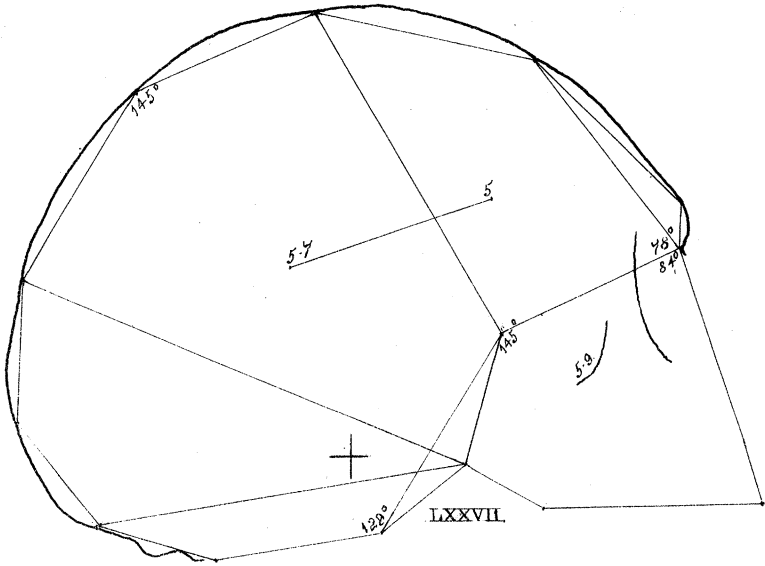
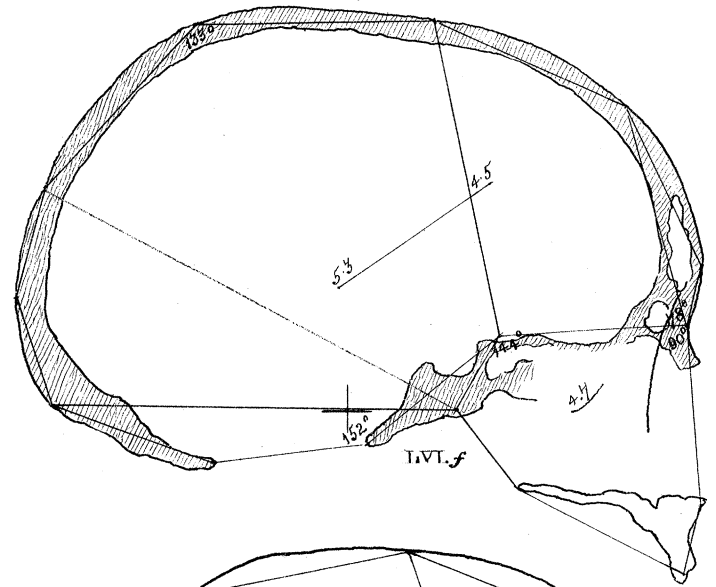
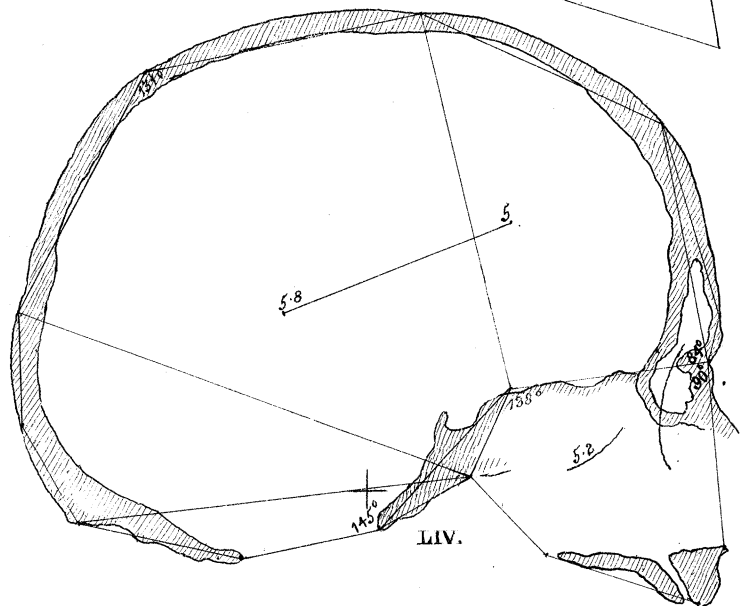
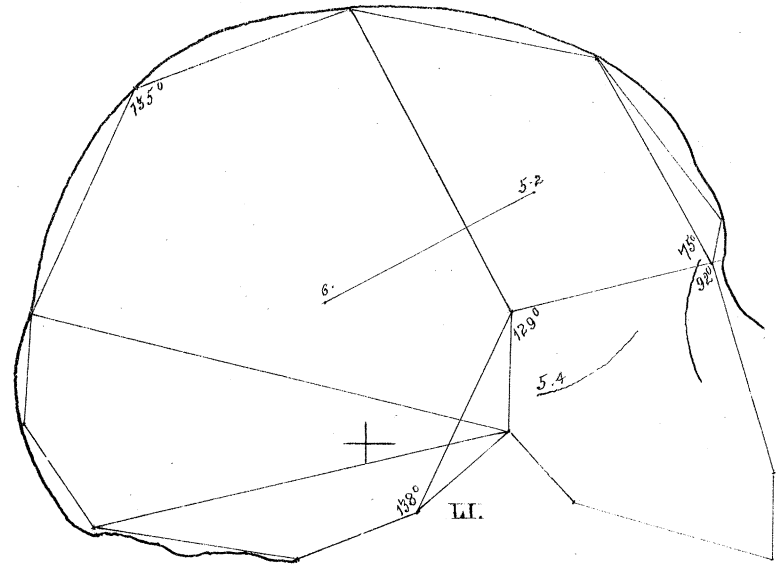
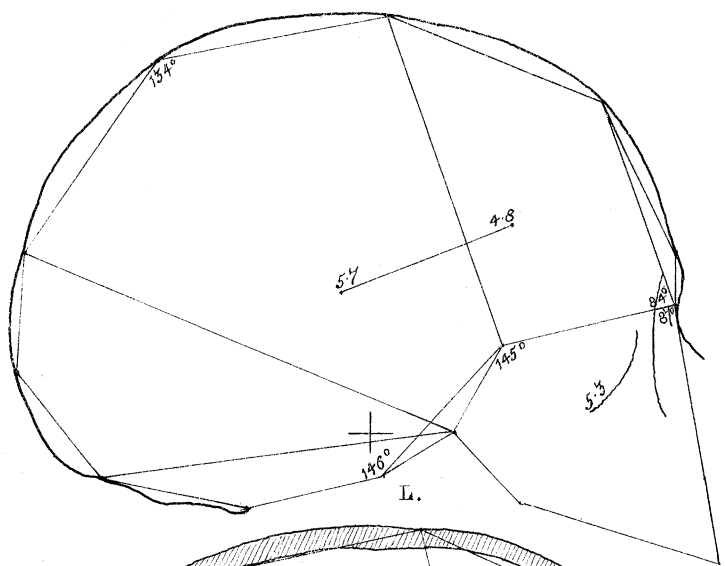

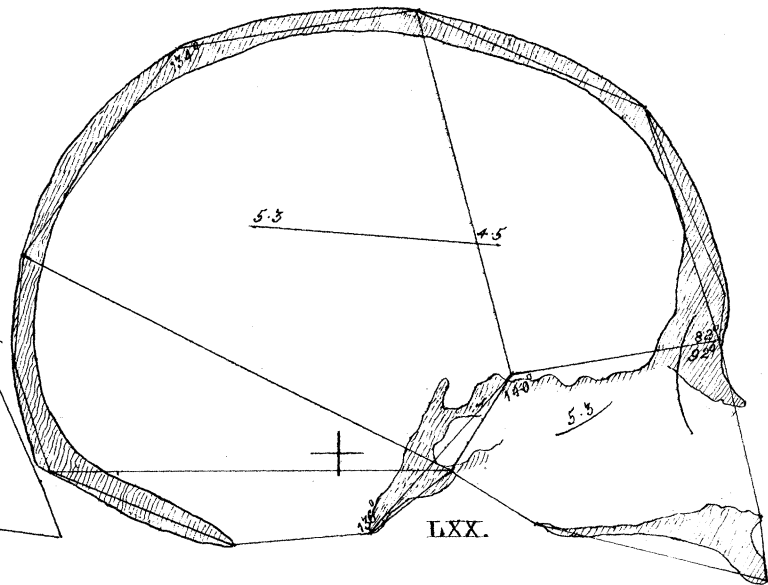
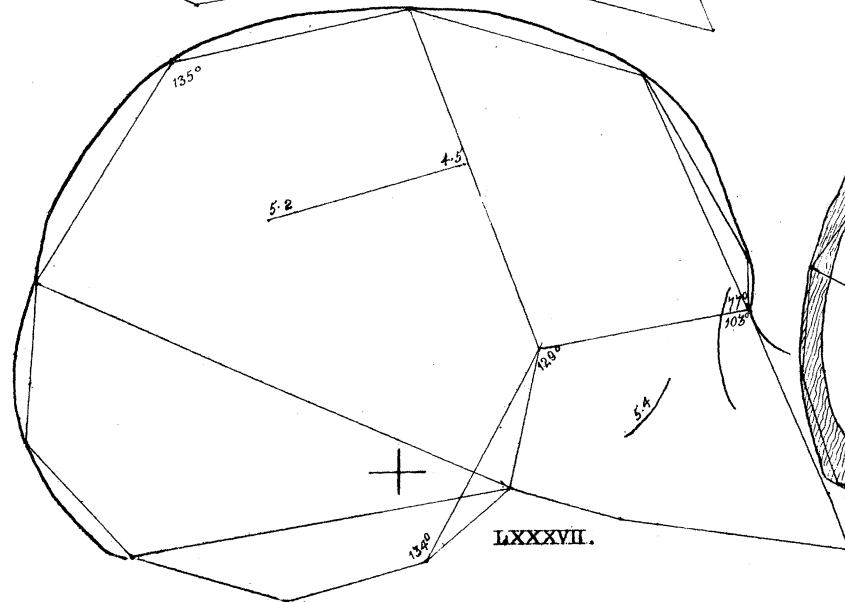
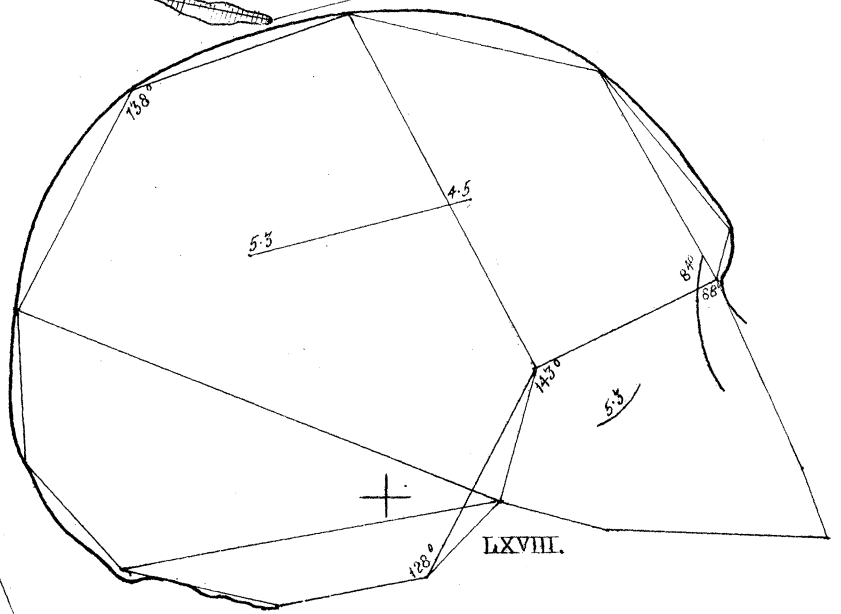
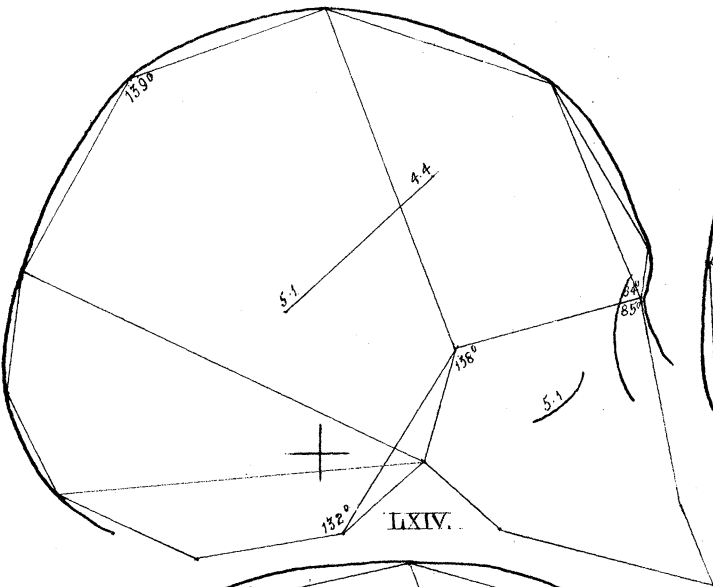
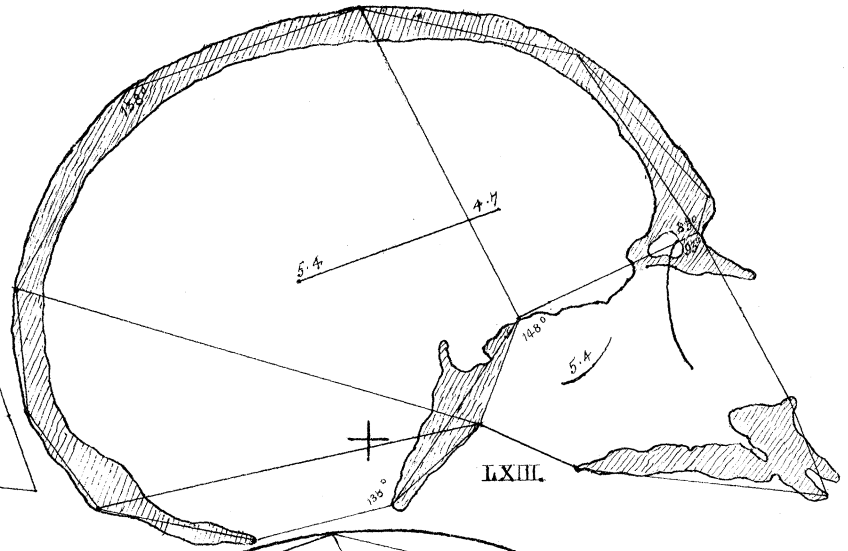
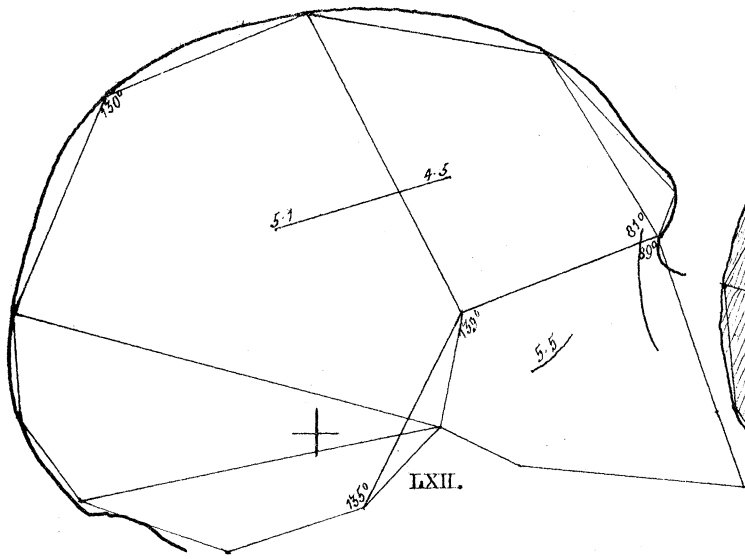

LXII, LXIII, LXIV *Negro*  
LXVIII, LXX. *Kafir* LXXXVII. *Hottentot*.

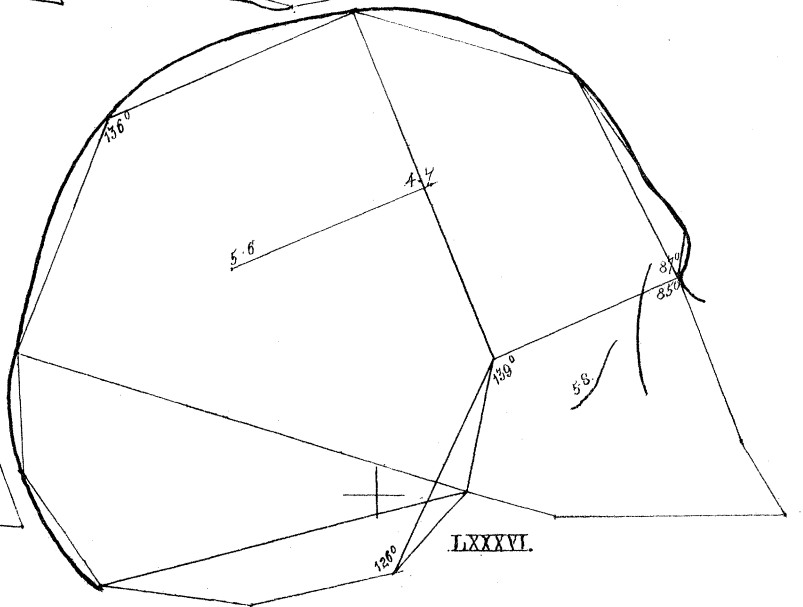
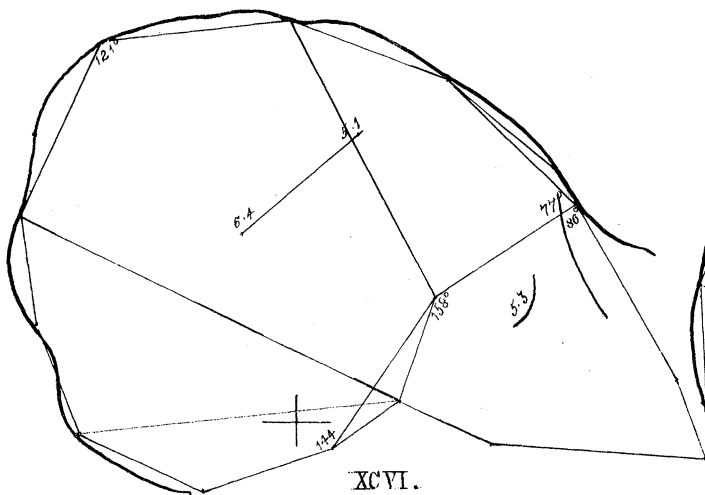
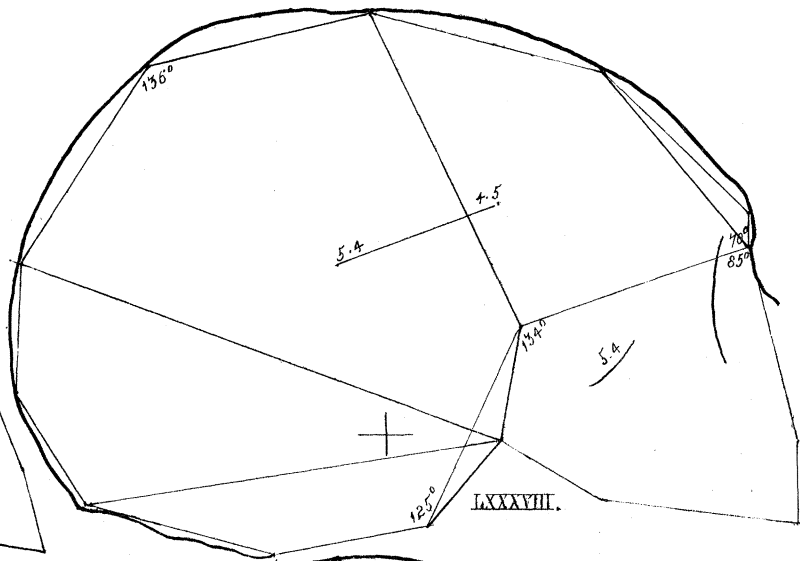
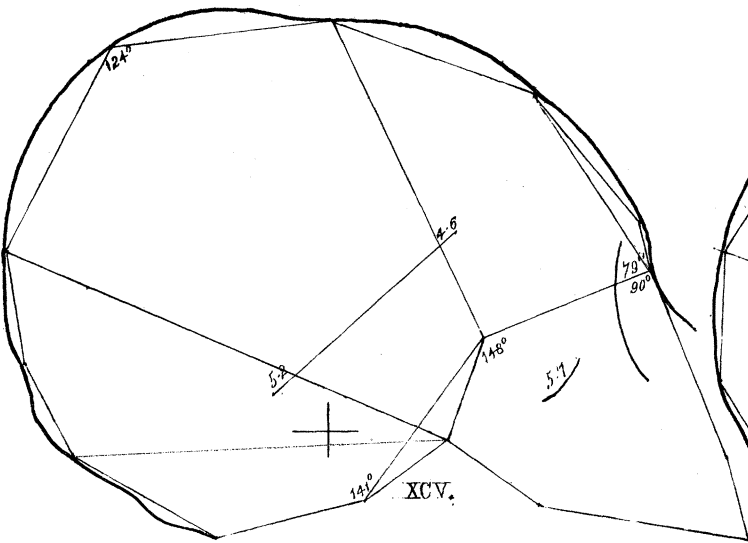
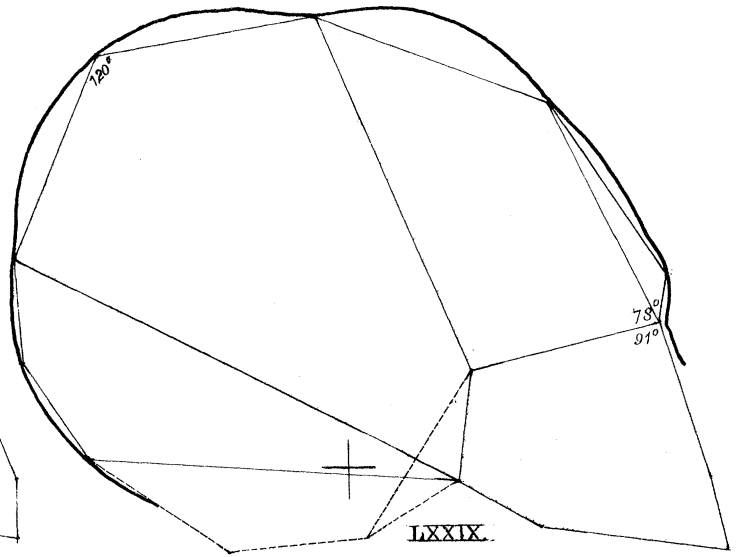
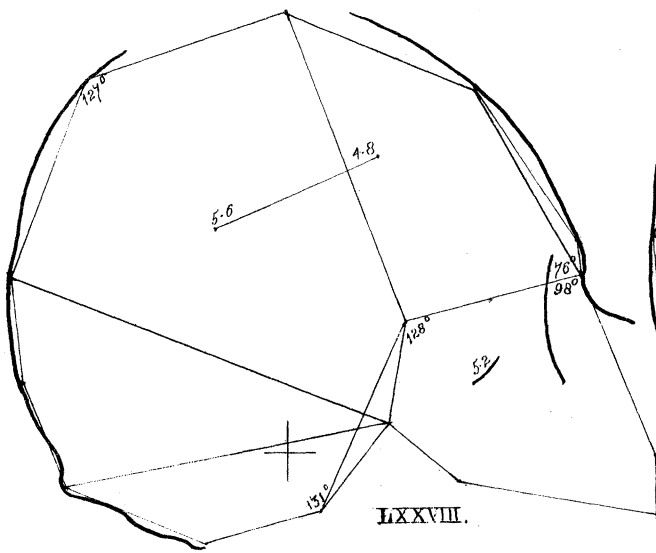

LXXVIII, LXXIX, *Peruvian (Inca)*. LXXXVI. *Maori*. LXXXVIII. *Carib*.  
 XCV. *Compressed Chinook*. XCVI. *Flattened American*.



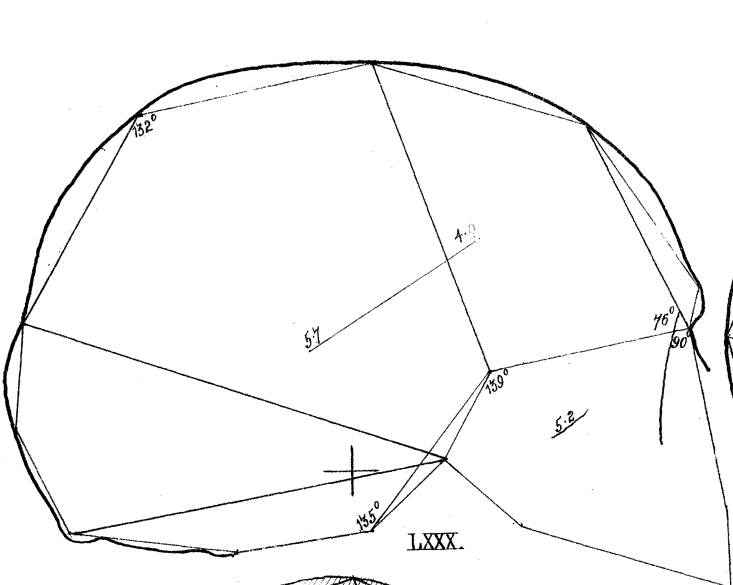

LXXX.

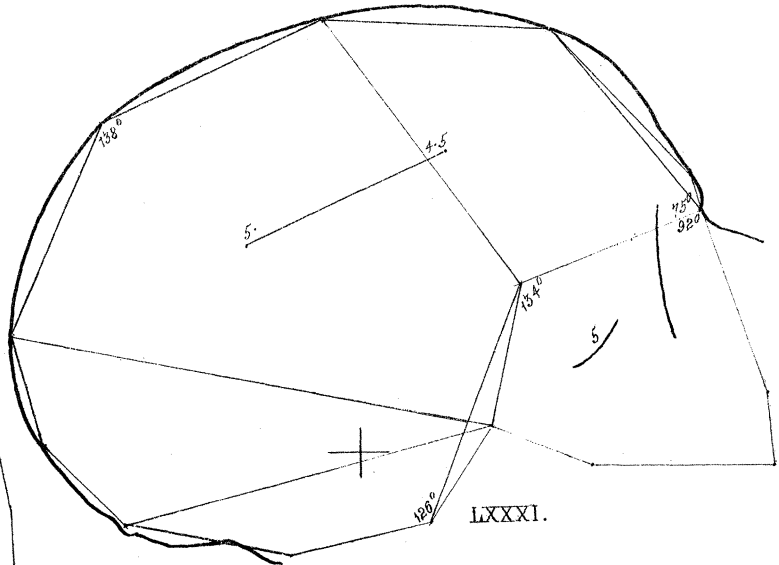

LXXXI.

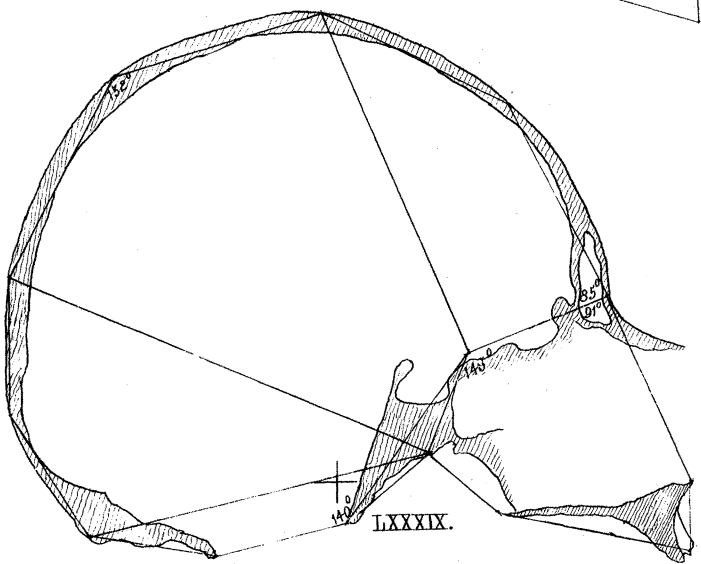

LXXXIX.

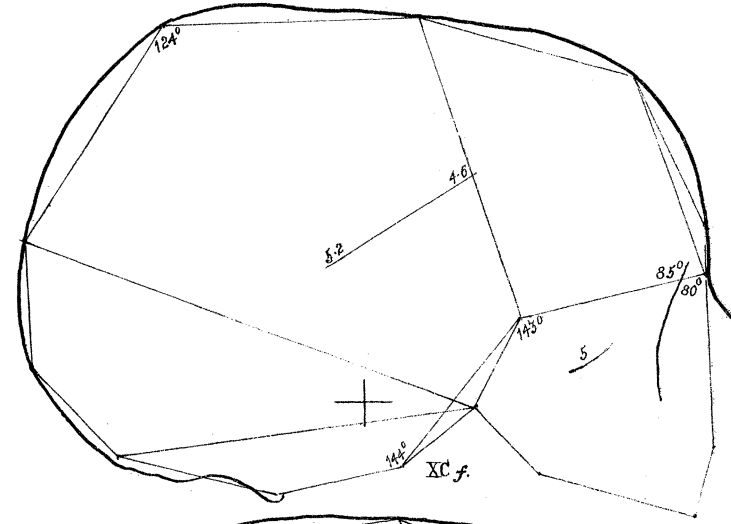

XC f.

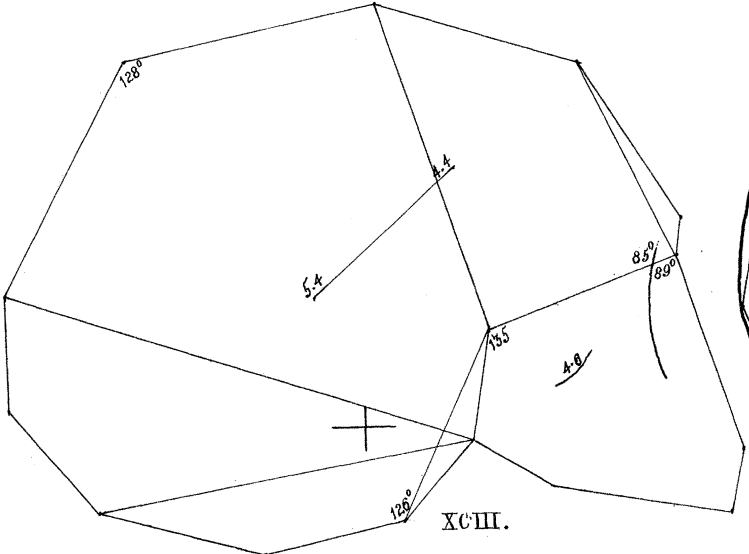

XCIII.

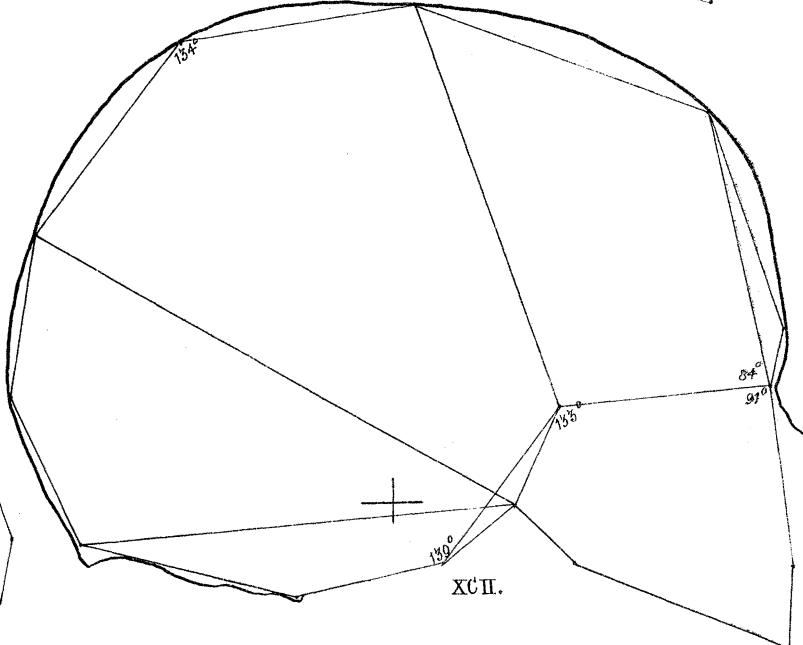

XCII.

LXXX. *Burke*. LXXXI. *Spanish pirate*. LXXXIX. *Synostotic French*. XC f. *Elongated form*. XCIII. *Hunchback*. XCII. *Anomalously large*.

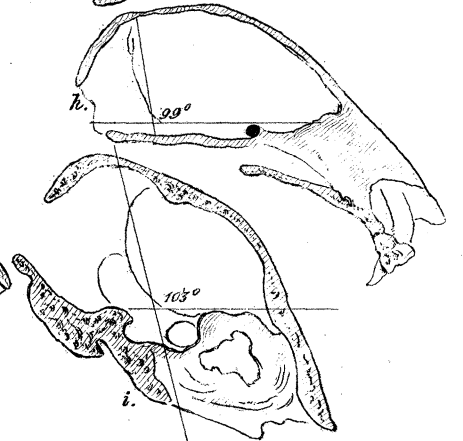
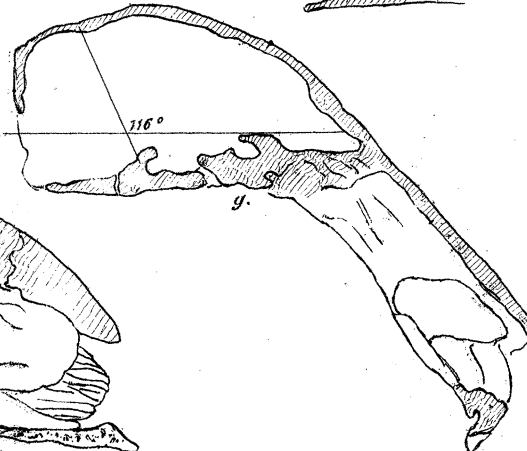
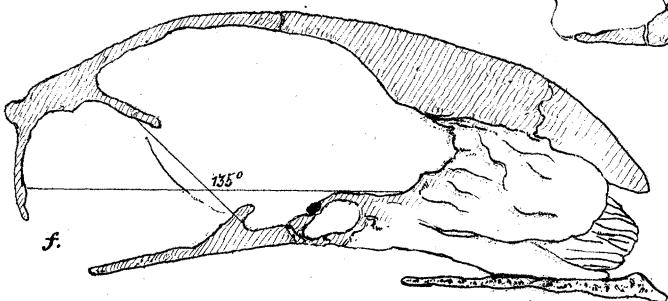
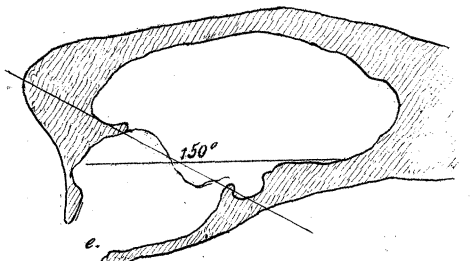
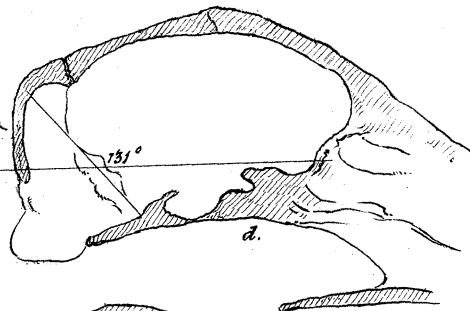
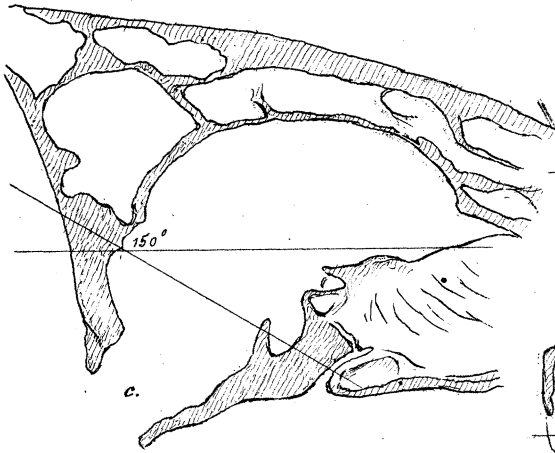
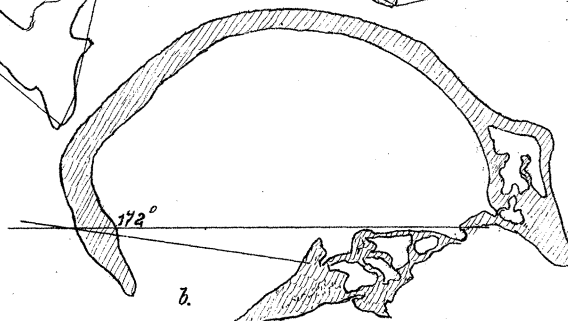
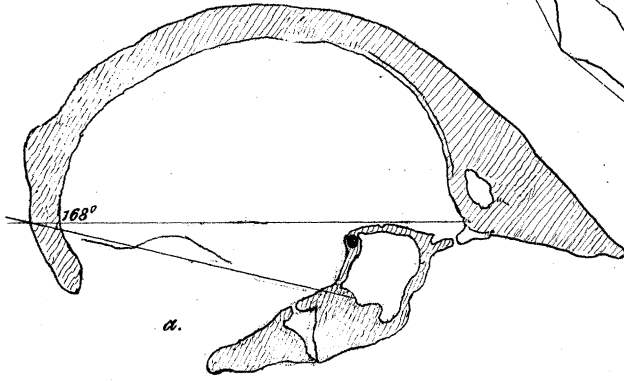
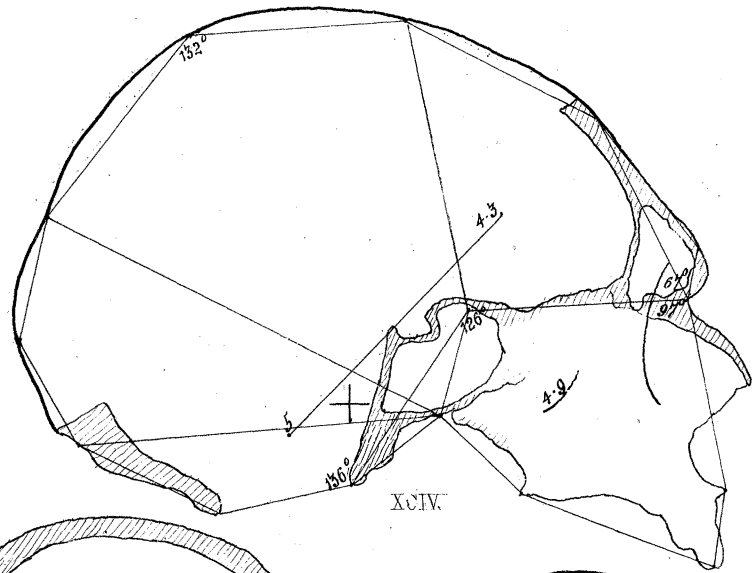
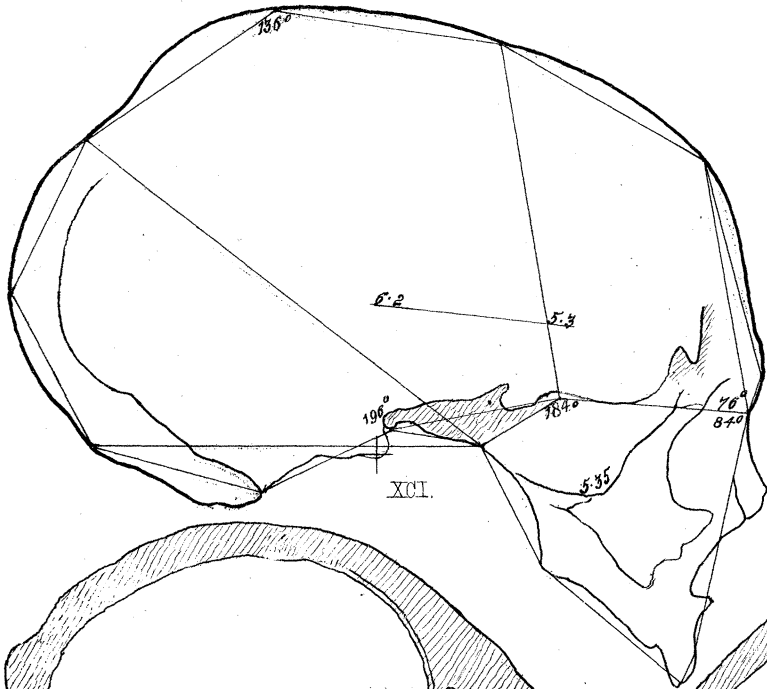

XCI. Base driven in XCIV Idiot. — a. Orang. b. Chimpanzee. c. Pig d. Deer. e. Dog. f. Cat. g. Rabbit. h. Squirrel. i. Turkey. \* Male & Female profiles. —



List of Skulls measured. (E. stands for Anatomical Museum, University of Edinburgh; E.N. for Natural-History Museum of that University; T. for Professor Thomson's Collection; and Q.C.G. for Queen's College, Galway.)	The arch and its portions.							Chords of portions of the arch.				Angles connected with the arch.						Pons of the base.				Angles connected with the base.				Distance of various points in the arch from the base.													
	From foramen magnum to occipital tuberosity.	From occipital tuberosity to upper angle of occipital bone.	Occipital arc from foramen magnum upwards.	Parietal arc along the sigmoid suture.	Frontal arc to fronto-nasal suture.	Total arch from foramen magnum to fronto-nasal suture.	Baseline from back of foramen magnum to fronto-nasal suture (chord of total arch).	Proportion of arch to the base reckoned as 1.	Proportion of occipital arc to parietal arc reckoned as 100.	Proportion of frontal arc to parietal arc reckoned as 100.	Occipital chord.	Parietal chord.	Frontal chord.	Proportion of occipital chord to parietal chord reckoned as 100.	Proportion of frontal chord to parietal chord reckoned as 100.	Postfrontal angle.	Angle at occipital tuberosity.	Midoccipital angle.	Occipito-parietal angle.	Midparietal angle.	Fronto-parietal angle.	Midfrontal angle.	Orbito-frontal angle.	Orbito-nasal angle.	Length of foramen magnum.	Foramen magnum line from foramen magnum to level of optic foramen.	Orbital depth from foramen magnum to fronto-nasal suture.	Foramen-lacrimal angle.	Orbito-lacrimal angle.	Angle of cranial curve.	Foramen-palatinal angle.	Deep frontal angle.	Occipital depth from spheno-occipital suture to occipital tuberosity.	Occipito-parietal depth from spheno-occipital suture to top of occipital.	Parietal depth from spheno-occipital suture to midparietal point.	Frontal depth from optic foramen to fronto-parietal suture.	Proportion of occipital depth to parietal depth reckoned as 100.	Proportion of occipito-parietal depth to parietal depth reckoned as 100.	Proportion of frontal depth to parietal depth reckoned as 100.
	1	2	3	4	5	6	7	8	9	10	11	12	13	14	15	16	17	18	19	20	21	22	23	24	25	26	27	28	29	30	31	32	33	34	35	36	37	38	39
<b>FOETAL SKULLS.</b>																																							
1. Four months old, wet	3	5	14	1-5	3-35	1-45	2-31	57	82	75	1-2	1-	62	83	140	150	151	155	125	143	132	99	90	55	55	55	117	147	150	168	25	1-	1-25	1-4	1-05	71	95	75	
2. Five months old, dry, Q.C.G.	3	5	14	1-5	3-35	1-45	2-31	57	82	75	1-2	1-	62	83	140	150	151	155	125	143	132	99	90	55	55	55	117	147	150	168	25	1-	1-25	1-4	1-05	71	95	75	
3. Five months old, wet	3	5	14	1-5	3-35	1-45	2-31	57	82	75	1-2	1-	62	83	140	150	151	155	125	143	132	99	90	55	55	55	117	147	150	168	25	1-	1-25	1-4	1-05	71	95	75	
4. Seven months old, dry, Q.C.G.	3	5	14	1-5	3-35	1-45	2-31	57	82	75	1-2	1-	62	83	140	150	151	155	125	143	132	99	90	55	55	55	117	147	150	168	25	1-	1-25	1-4	1-05	71	95	75	
5. Eight months old, dry, Q.C.G.	3	5	14	1-5	3-35	1-45	2-31	57	82	75	1-2	1-	62	83	140	150	151	155	125	143	132	99	90	55	55	55	117	147	150	168	25	1-	1-25	1-4	1-05	71	95	75	
6. Eight months old, dry, Q.C.G.	3	5	14	1-5	3-35	1-45	2-31	57	82	75	1-2	1-	62	83	140	150	151	155	125	143	132	99	90	55	55	55	117	147	150	168	25	1-	1-25	1-4	1-05	71	95	75	
Average	3	5	14	1-5	3-35	1-45	2-31	57	82	75	1-2	1-	62	83	140	150	151	155	125	143	132	99	90	55	55	55	117	147	150	168	25	1-	1-25	1-4	1-05	71	95	75	
<b>AT BIRTH.</b>																																							
7. Recent section	1-1	1-8	2-9	3-5	2-4	8-8	2-9	3-03	82	68	2-6	2-9	2-2	90	75	142	148	145	134	125	162	131	88	102	7	1-1	1-1	148	147	181	205	85	2-2	3-2	3-15	2-	69	101	63
8. E. (Monro's) 1	1-2	1-8	2-9	3-5	2-4	8-8	2-9	3-06	85	77	2-5	2-95	2-3	81	77	140	155	155	143	127	160	130	88	101	8	1-1	1-12	148	155	178	198	78	2-2	3-1	2-5	2-2	74	93	66
9. E. (Monro's) 2	1-3	1-6	2-9	3-5	2-7	9-1	2-9	3-11	82	77	2-45	2-95	2-4	83	81	140	152	142	148	124	152	131	91	103	8	1-1	1-15	143	142	178	188	85	2-15	3-1	2-5	2-2	78	93	69
10. E. 498	1-1	1-55	2-65	3-45	2-7	8-8	2-8	3-14	76	78	2-35	3-	2-4	78	80	156	159	155	131	152	133	93	107	7	1-2	1-15	128	140	168	194	85	2-15	3-	2-5	2-2	78	93	69	
11. E. 123 c	1-2	1-4	2-6	3-2	3-	8-8	2-8	3-13	76	78	2-35	3-	2-4	78	80	156	159	155	131	152	133	93	107	7	1-1	1-1	139	142	177	201	92	2-5	3-	2-5	2-2	78	93	69	
Average	1-1	1-8	2-9	3-5	2-4	8-8	2-9	3-06	82	68	2-6	2-9	2-2	90	75	142	148	145	134	125	162	131	88	102	7	1-1	1-1	148	147	181	205	85	2-2	3-2	3-15	2-	69	101	63
<b>AFTER BIRTH.</b>																																							
12. 1 year old, E. 123 b	1-6	2-	3-6	4-4	3-4	11-4	3-6	3-16	81	77	2-95	3-75	3-	78	80	159	134	142	152	124	150	134	88	93	1-05	1-35	1-4	134	139	175	198	88	3-2	3-9	4-	2-7	80	97	67
13. 2 years, girl, T.	1-6	2-	3-6	4-4	3-4	11-4	3-6	3-16	81	77	2-95	3-75	3-	78	80	159	134	142	152	124	150	134	88	93	1-05	1-35	1-4	134	139	175	198	88	3-2	3-9	4-	2-7	80	97	67
14. 3 years, E. 123 c	1-6	2-	3-6	4-4	3-4	11-4	3-6	3-16	81	77	2-95	3-75	3-	78	80	159	134	142	152	124	150	134	88	93	1-05	1-35	1-4	134	139	175	198	88	3-2	3-9	4-	2-7	80	97	67
15. 5 years, E. 123 b	1-6	2-	3-6	4-4	3-4	11-4	3-6	3-16	81	77	2-95	3-75	3-	78	80	159	134	142	152	124	150	134	88	93	1-05	1-35	1-4	134	139	175	198	88	3-2	3-9	4-	2-7	80	97	67
16. 5 years, E. 123 c	1-6	2-	3-6	4-4	3-4	11-4	3-6	3-16	81	77	2-95	3-75	3-	78	80	159	134	142	152	124	150	134	88	93	1-05	1-35	1-4	134	139	175	198	88	3-2	3-9	4-	2-7	80	97	67
17. 6 years, E. 115	1-8	2-6	4-4	5-4	5-	14-8	4-7	3-15	81	92	3-7	4-9	4-25	75	86	148	154	154	139	147	145	89	87	1-4	1-75	1-85	137	134	182	212	93	3-8	4-9	5-5	3-8	73	93	73	
18. 10 years, boy, E. 6	2-4	2-4	4-4	5-4	5-2	15-4	5-1	3-02	88	96	3-95	4-7	4-5	84	95	144	137	147	155	132	148	138	85	89	1-6	1-95	1-8	128	137	181	210	96	4-4	5-15	5-4	3-85	81	95	71
Average	1-6	2-	3-6	4-4	3-4	11-4	3-6	3-16	81	77	2-95	3-75	3-	78	80	159	134	142	152	124	150	134	88	93	1-05	1-35	1-4	134	139	175	198	88	3-2	3-9	4-	2-7	80	97	67
<b>PERUANS.</b>																																							
19. Male, E. No. 21	1-9	2-6	4-5	4-5	4-8	13-8	5-3	2-60	100	106	3-7	4-	4-5	92	112	139	127	155	160	134	148	133	79	93	1-25	2-2	2-	152	147	185	214	97	3-9	4-55	5-	3-7	78	91	74
20. " E. No. 24	1-3	3-1	4-4	4-5	4-7	13-6	5-5	2-47	97	104	3-7	4-2	4-4	88	104	138	140	142	146	137	151	136	70	97	1-5	2-15	1-55	134	135	179	202	105	3-65	4-9	4-95	3-4	73	98	68
21. " E. No. 25	2-2	2-2	4-4	4-5	4-9	14-3	5-1	2-80	88	98	3-6	4-5	4-5	80	100	147	138	141	161	133	144	175	77	103	1-4	2-2	1-85	137	134	183	213	101	4-1	4-75	5-1	3-7	79	93	72
22. " E. No. 26	1-6	2-6	4-2	4-9	4-6	13-7	5-6	2-44	83	93	3-5	4-3	4-2	81	97	141	129	158	155	129	151	138	79	86	1-5	2-2	2-05	150	144	186	216	94	3-7	4-4	4-9	3-5	75	89	70
23. " E. No. 28	1-7	2-6	4-2	4-6	4-9	13-8	5-	2-76	93	106	3-7	4-3	4-3	86	100	152	138	148	145	152	152	131	77	91	1-6	2-2	1-75	153	153	182	209	103	3-6	4-7	4-9	3-5	75	89	70
24. " E. Old Soldier	1-8	3-4	5-2	4-4	5-2	14-8	5-7	2-59	118	118	3-9	4-	4-6	97	115	163	134	141	149	144	153	132	77	83	1-6	2-2	1-75	153	153	182	209	103	3-6	4-7	4-9	3-5	75	89	70
25. Female, E. No. 27	1-6	2-7	4-3	4-7	4-8	13-8	5-1	2-70	91	102	3-6	4-2	4-3	85	102	140	141	149	152	153	138	84	86	1-4	1-95	1-9	136	152	189	218	96	3-5	4-5	4-7	3-7	74	95	78	
26. " E. No. 29	1-8	2-5	4-3	5-05	4-95	14-3	4-9	2-91	85	98	3-6	4-5	4-4	80	97	148	137	152	151	131	147	136	81	86	1-5	2-15	1-7	136	158	188	211	104	3-8	4-7	5-2	3-6	73	90	69
27. " E. No. 23	1-9	2-5	4-4	4-7	4-7	13-8	5-	2-76	93	100	3-8	4-	4-3	85	107	140	133	164	150	121	157	138	81	85	1-4	2-	1-9	139	133	186	213	99	3-7	4-7	5-2	3-5	71	90	67
Average	1-9	2-6	4-5	4-5	4-8	13-8	5-3	2-60	100	106	3-7	4-	4-5	92	112	139	127	155	160	134	148	133	79	93	1-25	2-2	2-	152	147	185	214	97	3-9	4-55	5-	3-7	78	91	74
<b>GERMANS.</b>																																							
28. Male, E. No. 37	1-8	2-8	4-6	4-5	5-7	14-8	5-1	2-90	102	126	3-7	4-1	4-9	90	120	158	122	158	146	137	146	128	76	94	1-4	2-1	1-9	147	138	189	212	110	3-8	4-8	5-1	3-9	74	94	76
29. " E. No. 37 a	1-8	2-8	4-6	4-5	5-7	14-8	5-1	2-90	102	126	3-7	4-1	4-9	90	120	158	122	158	146	137	146	128	76	94	1-4	2-1	1-9	147	138	189	212	110	3-8	4-8	5-1	3-9	74	94	76
30. " E. No. 41	2-	2-7	4-7	4-7	5-1	14-5	5-3	2-73	100	108	3-7	4-3	4-4	86	102	151	120	144	156	133	153	137	78	89	1-35	2-3	1-95	141	138	183	201	102	4-1	4-8	5-	3-5	82	96	72
31. " E. No. 42	1-7	2-8	4-5	5-	5-																																		



